



~ From food products to industrial oil ~

20 Applications

 ATAGO®

20 Applications

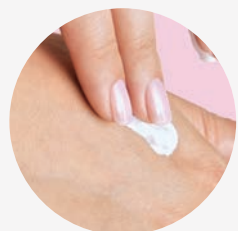

A4
Lotion and
Hand Cream



A5
Toothpaste



A6
Yogurt



A7
Ice cream



A16
Okayu
(Rice Porridge/Congee)

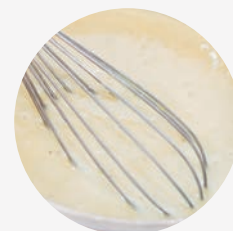

A17
Frying Batter

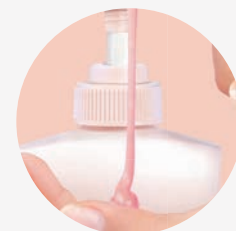

A18
Shampoo



A19
Conditioner



A8
'Anko' (Bean paste)



A9
Miso



A10
Sauce



A11
Curry



A20
Paint



A21
Cleaning solution

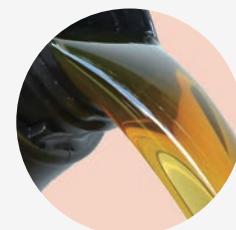

A22
Engine oil



A23
Thickening agent



A12
Tomato Ketchup



A13
Butter



A14
Chocolate

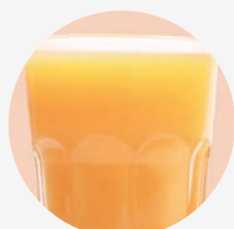

A15
Beverages

Lotion and Hand Cream

The texture when applied to skin is one of the most important elements

The main purpose of lotion is to protect and moisturize the skin. There are many types such as body cream, hand

cream, and lip cream but all are basically composed of some kind of oil, such as mineral oil or Vaseline, water, an emulsifier in order to mix the two, a moisturizing agent, and fragrance. There are differences in texture depending on the balance of the combined ingredients, anything from a lotion that is light and absorbs quickly to thicker deep moisturizing creams. Texture is an important factor in choosing a hand cream and many consumers choose based on the season or even their mood.

★ Viscosity of Hand Cream

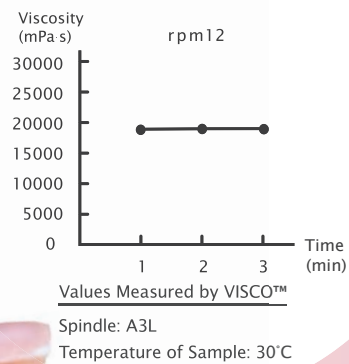

Hand cream



Compared to other parts of the body, hands are frequently exposed to water and other outside stimuli elements so hand creams contain either solid or highly viscous oil.

Body Cream



Body cream tends to be of lighter texture and contains less oil so that it can be easily applied all over the body. Some body creams are thicker and contain more oil to moisturize dry parts of the body, like knees or heels.

Customer comments

The customer's company produces many types of hand lotions and body creams. The customer does not only use the VISCO™ for quality purposes but to test samples from products returned as defective or in the case of a user dispute. Due to the fact that the customer has users all over the world, the products are exposed to many different climates and temperatures. The consistency of the products can change due to climate. The company makes a wide range of lotions from very high to low viscosity. Products of the highest and lowest viscosity were the hardest to get a stable measurement. But since using the VISCO™, the customer has been able to go stable results despite the viscosity of the product.

Quality control of Lotion and Creams

A refractometer or polarimeter is used for the intake inspection of raw materials. For Polarimeters the portable RePo™-5 or for high accuracy, the AP™-300 and SAC-i™ are recommended. As for refractometers, either the easily portable PAL™ series or the highly accurate RX™ series are recommended. For pH management PAL™-pH is recommended.



Toothpaste

Toothpaste is called tooth power because long ago powder was used.

Toothpaste not only keeps the mouth clean but prevents cavities, stained teeth and periodontal diseases. Plaque is bacteria that is adhered to the tooth. Just one centimeter of plaque can contain one hundred million bacterium. It is difficult to rinse plaque with just water as it strongly adheres to the teeth. Plaque buildup causes not only poor oral health but bad breath, cavities, and periodontal diseases so it is important to brush teeth thoroughly using a toothbrush. It is possible to remove plaque with just a toothbrush but by using toothpaste, you can prevent the formation of

plaque. Toothpaste, being a highly viscous paste, allows the active ingredients of the toothpaste to absorb deeply into the periodontal pocket or gums. If toothpaste is too hard, it is difficult to squeeze out of the tube and if too runny, one ends up using too much toothpaste and it is difficult to get on the brush. Viscosity has a very important role in the makeup of toothpaste.

★ Viscosity of Toothpaste

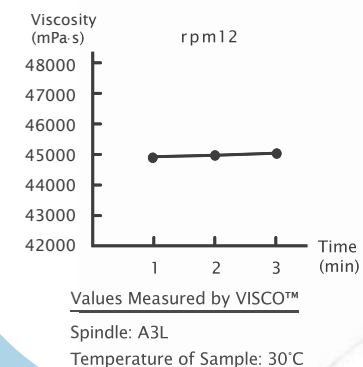

General Ingredients of Toothpaste



- Polishing Agent: To remove plaque, discoloration or stains.
- Lubricant: To prevent toothpaste from drying out.
- Foaming Agent: The foam helps distribute the active ingredients throughout the mouth.
- Binding Agent: Keeps toothpaste in paste form.
- Flavoring Agent: Adds flavor and scent to make the toothpaste easier to use and makes it more refreshing
- Preservatives: to keep the product from deteriorating

Quality control of toothpaste

A refractometer or polarimeter is used for the intake inspection of raw materials. For polarimeters the portable RePo™-5 or for high accuracy, the AP™-300 and SAC-i™ are recommended. As for Refractometers the PAL™ series or the highly accurate RX™ series is recommended. For pH management the PAL™-pH is recommended.



Yogurt

Thicker yogurt is better for health!?

The two major reasons that yogurt is said to be good for your health is that it is high in nutrients and full of healthy bacteria such as lactic acid bacteria. There are many types of bacterium found in yogurt and the mix depends

on the type or even brand of yogurt. The type of bacteria used can determine the texture and taste. For example thicker yogurts tend to include EPS, which is one of the byproducts produced by the bacteria during the

fermentation process. EPS or Exopolysaccharide is known to boost the immune system which is one of the reasons yogurt is considered to be healthy.



Viscosity of Yogurt

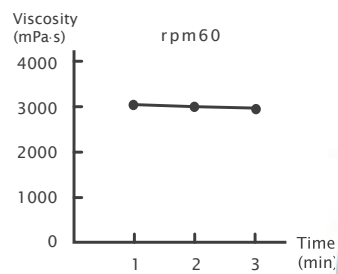

Values Measured by VISCO™

Spindle: A2L

Temperature of Sample: 30°C



Manufacturing Process of Yogurt

There are two ways yogurt is manufactured. It is either fermented in the package or fermented in a tank before being packaged. This manufacturing process affects the texture of the yogurt. Yogurt that is fermented before being packaged is of a thinner, smoother consistency and mainly used as yogurt drinks and yogurt with fruits. As for thicker, pudding like yogurts, the fermentation process happens after being packaged.

Ezaki Glico Corporation Ltd.

At Ezaki Glico they are measuring the viscosity of the yogurt and custard pudding. They purchased VISCO™ (Package B) to use at their factories because of its portability. The VISCO™ received highly positive feedback saying not only is the VISCO™ small and stylish but the measurements are very accurate.

Quality control of yogurt

Manufacturing yogurt, not only viscosity is important but also controlling the thickness and acidity of the yogurt, as it determines the taste. When controlling the thickness and acidity, the PAL™-BX|ACID96 is recommended. For pH management, the PAL™-pH.



PAL™-BX|ACID96 PAL™-pH

Ice cream

Smooth, melt in your mouth texture key?!



Viscosity of Ice cream

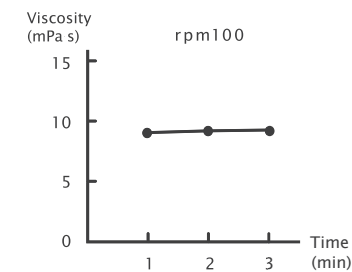

Values Measured by VISCO™

Spindle: ULA

Temperature of Sample: 30°C

On a hot summer day, one tends to yearn for ice cream. Just the sight of ice cream can be refreshing. As of late, ice cream is eaten not only during summer but also during winter months many find eating ice cream in the comfort of their warm, cozy, room can be particularly satisfying, making ice cream popular all year round. During winter creamy and more flavorful ice creams tend to be preferred and it turns out that there is a particular reason for this. In the winter, the body's metabolism increases to maintain body temperature and, concentrations of Leptin in the blood to decrease as fat decreases. When Leptin levels in the blood decrease the body tends to crave sugary foods and causes sugary foods to taste all the better. The key to the happiness one bite of ice cream can bring you is the smooth and melt in your mouth quality and behind all of it is the proper viscosity management.

Foremost Blue Seal Ice Cream

At Foremost Blue Seal Ice Cream, the VISCO™ is used to control the viscosity of the ice cream mix. How the ice cream melts in your mouth directly relates how delicious the ice cream is, so Foremost Blue Seal uses the VISCO™, especially while developing new flavors. It is important to determine the proper viscosity for each development stages. In order to later prevent equipment failure, when refilling the ice cream tubs. The customer loved the fact that the VISCO™ was so easy to use, even for first time users and that very little sample was needed to get an accurate measurement.

Quality control of ice cream

Because ice cream is eaten cold, it is important to control the sweetness that can be tasted once placed in the mouth. To monitor sweetness, the PAL™-Pâtissier is recommended and as for pH control the PAL™-pH is recommended.



PAL™-Pâtissier PAL™-pH

'Anko' (Bean paste)

Said to be eaten in Japan from the Kamakura period (1185-1333) and essential in Japanese Confectionary.

Red bean paste or Anko is essential in Japanese Confectionary. There are many types of sweets made with red bean paste including red bean mochi, Oban-Yaki (a muffin type sweet with red bean paste inside), red bean doughnuts, and Monaka (wafer sandwich with red bean paste inside). The secret to the deliciousness of red bean paste is in the elegant sweetness of the Azuki beans, and smooth creamy texture.

The texture of red bean paste is said to come from the starch in the beans expanding as they come in contact with water during the cooking process. The starchiness of

the beans depends on the bean type and can affect the overall flavor of the paste.

It is said that the viscosity of red bean paste comes from one of the starch component found in beans called Amylose. Beans with low levels of Amylose tend to be more viscous. Once again, the flavor and sweetness of red bean paste is determined by the type of bean used. How the paste is made can also affect the texture and taste such as

the cooking time, temperature, and how long the beans are steamed. If the beans are over cooked the red bean paste becomes too sticky. The careful selection of high quality beans and the right manufacturing technology or method is essential in order to produce delicious red bean paste.

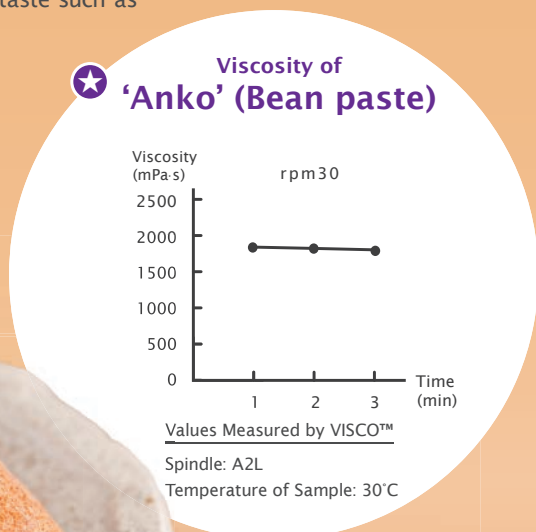

The delicious relationship of 'Anko' (red bean paste) and sugar

'Anko' (red bean paste) is made by adding sugar to cooked red beans and is further into a paste. Preferences regarding sweetness of the red bean paste depends on region and climate. The sweetness of red bean paste depends on the sweetness of the beans and the amount of sugar added, and how long the beans were cooked. Each manufacturer uses their own know how to determine the flavor of their red bean paste.

Quality control of Anko (red bean paste)

The PAL™-J is recommended to measure sugar levels of Anko (red bean paste) and the PAL™-SALT for salt levels. As for pH, the PAL™-pH is recommended.



Miso

Traditional Japanese Fermented Food

Miso is a traditional Japanese food that has been a staple of the Japanese diet for over 1,300 years. As of late, miso being fermented food, has gained attention from all over the world for its health benefits. Miso is an essential ingredient for many Japanese dishes. It is most commonly used in miso soup, which is known to Japanese people as a comfort food and considered to be Ofukuro no aji which means "Mom's Taste". The flavor of miso is comprised of a complex mixture of sweetness, saltiness,

umami, acidity, and bitterness of which all components must be in harmony. Unlike soy sauce, miso does not have any Japanese Agricultural Standards (JAS). There are so many varieties that it would be difficult to classify them all. Miso contains live, active cultures and cannot be classified as it is constantly changing. Also, there are many miso products which do not undergo heat sterilization, and for this reason, setting or maintaining physicochemical analytical values is impossible. Miso manufacturers check the

moisture content, temperature, and conduct chemical testing and microorganism testing. Lastly sensory inspections are conducted daily to ensure the taste of the miso and safety of the consumer.

Types of miso

Miso is classified largely by its raw ingredients; kome (rice), mugi (barley), mame (bean) and 'chougou' or mixed miso. Each type of miso has different ratios of soybean, rice, barley, and salt.

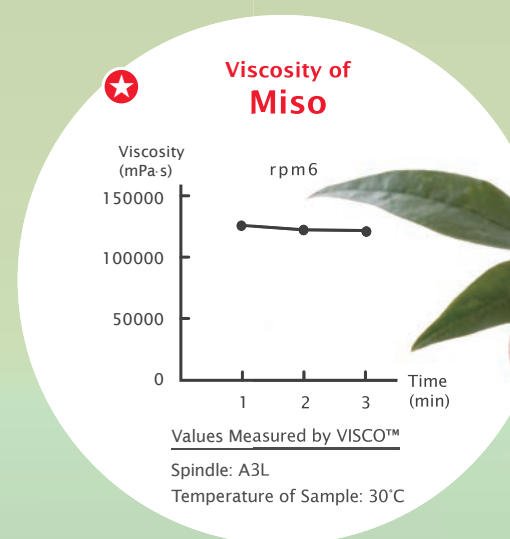

Tsuru Miso Jozo Co., Ltd.

Tsuru Miso Jozo was founded during the Meiji period (1871) and is located in Yanagawa City in the Fukuoka Prefecture. Having a history of over 140 years, their motto is to follow tradition and keep up the same formula and taste. They also make miso used in miso dispensers in the food industry. The miso used in dispensers has to be of a certain consistency or viscosity in order to dispense the same amount every time.

Miso that is too viscous will cause the dispenser to become clogged and break, so it is all the more important to make sure the miso is at the right viscosity. When Tsuru Miso Jozo tried the VISCO™, they were very pleased at just how easy it was to use. The VISCO™ only requires a small amount of product in order to get a measurement so Tsuru Miso Jozo was happy that their miso would not go to waste.

Quality Control of Miso

In order to monitor the concentration of miso, PAL™-J is recommended and for salt content, the PAL™-SALT is recommended. For pH, the PAL™-pH is recommended.



Sauce

The Proper Viscosity is the Key to Delicious Sauce that Mixes Well with Food

Whether it be Japanese, Western, or Chinese food, there are many different types of sauces to bring out the delicious flavor of a dish. Demi-glace sauce, gravy sauce, oyster sauce, 'gyudon' sauce or beef bowl sauce, and 'unagi' sauce or eel sauce are just some of the many sauces used for dishes from appetizers to desserts. How well sauces cling to food depends on the thickness of the sauce so the key to delicious sauce is its viscosity. Without proper thickness, the sauce will not properly coat the food resulting in a bland flavor. Even sauces with same 'umami' flavor and amount of

salt, the food the flavor will differ depending on its viscosity. The viscosity of the sauce corresponds to how well it goes well the dish and it can vary from watery, non-viscous to very viscous sauces. To thicken a sauce, butter,

cream, flour, corn starch or potato starch is used. Viscosity, changes depending on how much it has been heated so it is important be aware of the right timing to turn off the heat.

★ Viscosity of 'Tonkatsu' Sauce (Pork Cutlets Sauce)

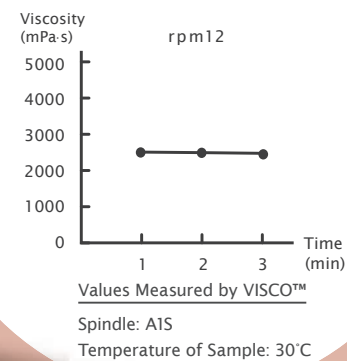

Customer comments

Our customer, a restaurant that offers Hamburg steaks uses the VISCO™ to manage their sauces, 'tare' (Japanese dipping sauce), and salad dressings. This customer is not only testing viscosity, but also carefully checking the concentration and salt content of their food.

Curry

What's Behind Curry Rice's thickness?

Curry is a popular dish eaten all over the globe. The ingredients and spices used in curry differs depending on the country, region, and dietary habits, which means each curry has a different aroma, color and spiciness. Japanese curry, which is popular in Japan, is thick and is generally eaten over rice. On the contrary, In-

dian Curry is of a thinner silky consistency and eaten with Indica rice or Indian flat bread, 'naan'. Indica rice is not sticky and compared to Japonica rice, when cooked, the rice does not stick together so goes well with the soupy curry. The thickness of Japanese curry comes from flour-based

starch. When heat is applied to flour, the starch becomes gelatinous. Additionally, curry 'Udon', (curry noodle) is a unique type of curry that that was developed in Japan, it consists of curry sauce thickened with potato starch to allow the curry sauce to adequately cling to the noodles.

★ Viscosity of Curry

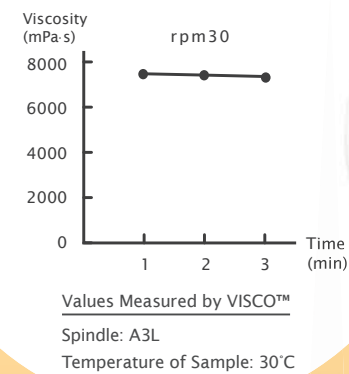

The origins of the word Curry

According to All Japan Curry Manufactures Association, there are few theories involving the word curry which is said to have originated from 'Kari' meaning sauce in the Tamil language or it may have come from 'Turcarrī' which means highly aromatic or delicious in the Hindu language. Spicy food from India and other subtropical surrounding areas are said to have been given the general term "curry" in the English language.

Customer comments

Our customer started using the VISCO™ during the production process after receiving a customer complaint saying "The sauce is not as thick as usual." Our tastes is affected by changes in physical condition and such so in order to measure the thickness objectively and numerically they choose the VISCO™. They are especially pleased with ease of use and low cost of the VISCO™.

Customer comments

Another customer started using the VISCO™ because if the viscosity of curry is too low, when curry is served over the rice, the sauce will run through the rice to the bottom of the plate which does not make it "delicious looking curry".

Quality Control of Sauces

The PAL™-H is recommended for testing consistency and PAL™-SALT for testing salt content. For monitoring pH PAL™-pH is recommended.



Quality Control of Curry

For measuring the viscosity, the heat tolerant PAL™-H is recommended. For salt concentration the PAL™-SALT is recommended. As for pH the PAL™-pH is recommended.



Tomato Ketchup

Tomato: The Most Produced Vegetable in the World.

Tomato puree is made by applying heat, straining, and boiling down ripe tomatoes into a thick puree.

When seasonings such as sugar, salt, vinegar, also vegetables such as onions and celery are added, to the tomato puree, it becomes ketchup. Ketchup is a versatile condiment that is loved by people from all over the world. It is used for western style food such as hot dogs, French fries, omelets, and

in Chinese food, it is used to make such food as stir-fried shrimp in chili sauce. When you think of a ketchup container what do you see? A container of ketchup can range from a glass bottle to a flexible plastic tube. When a ketchup container is turned upside down, the ketchup does not readily come out unless shaken or squeezed. Ketchup is a thixotropic fluid which is classified as a non-Newtonian fluid which has property of becoming a liquid like state when force is

applied and returns to gel like state without force. The thick viscous consistency of ketchup comes from the pectin in the tomato. Pectin is easily broken down by the enzymes found in tomatoes. For this reason, when making highly viscous ketchup or jam, this enzyme needs to be inhibited. On the contrary, when making other processed tomato products like juice that is low in viscosity, it is important to break down the pectin. In such a way, viscosity can influence the mouth feel.

★ Viscosity of Tomato Ketchup

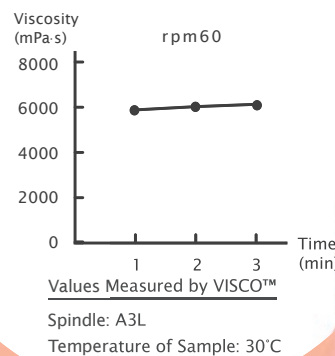

Customer comments

VISCO™ was selected for its portability and data storage capacity for onsite and quality control of tomato processing. This company manufactures various types of ketchup and tomato sauces for different uses. Their raw ingredients, viscosity, consistency, salt content, and pH levels varies. In addition to the VISCO™, this company is using ATAGO's salt meters and concentration meters.

Quality control of processed tomato products

For processed tomato products, concentration, salinity, and pH are generally tested. The highly accurate RX™ series or the CM™-800α with capability to test continuously on the production line are recommended. For salt content the PAL™-SALT is recommended. As for monitoring pH the PAL™-pH is recommended. To measure the sugar content or acidity of the raw tomatoes, the PAL™-BX|ACID3 is recommended.



Butter

A breakfast favorite, buttered toast

Not only is butter delicious but the aroma and richness are appealing to the senses. How do you like your buttered toast? Spreading butter on freshly toasted bread is simply divine. Some spread butter into their toast while others place slices of butter on their toast in order to further enjoy the aroma and texture of the butter. The basic simplicity of buttered toast is the very reason that there are so many ways to enjoy it, including how it is toasted, and how the butter is spread. Butter is considered to be a Bingham fluid meaning butter becomes more viscous with constant force. By applying

constant force to the knife one is easily able to spread butter on bread. Butter is a perishable item so must be stored below 10 degrees so butter is very hard when first taken out of the refrigerator. Cold butter is easily cut but too hard to spread on toast so there are, even when cold, easily spreadable butter spreads. These products are made softer with vegetable oil and other ingredients and in production process the butter spread's viscosity is studied under many different conditions.

Butter

Butter is according to the Japanese ministerial ordinance considering the compositional standards of milk products butter is defined as a highly concentrated form of fluid milk. It must have over 80% milk fat and less than 17% water content in order to be labeled and classified as butter.

Classifications butter by Manufacturing Method

[Fermented Butter]

Butter made by adding lactic acid to heavy cream and allowing it to ferment. Has a very rich aroma.

[Non Fermented Butter]

Butter made with heavy cream not by lactic acid fermentation. It has a fresh smooth taste and is the most commonly consumed butter in Japan.

Salted and Unsalted Butter

[Salted Butter]

Salt is added to butter during the whipping process. Salt enhances the flavor and allows for a longer shelf life. The amount of salt is roughly 1.5%.

[Unsalted butter]

Used mainly for cooking and baking. As there is no added salt the shelf life is shorter than salted butter

★ Viscosity of Butter

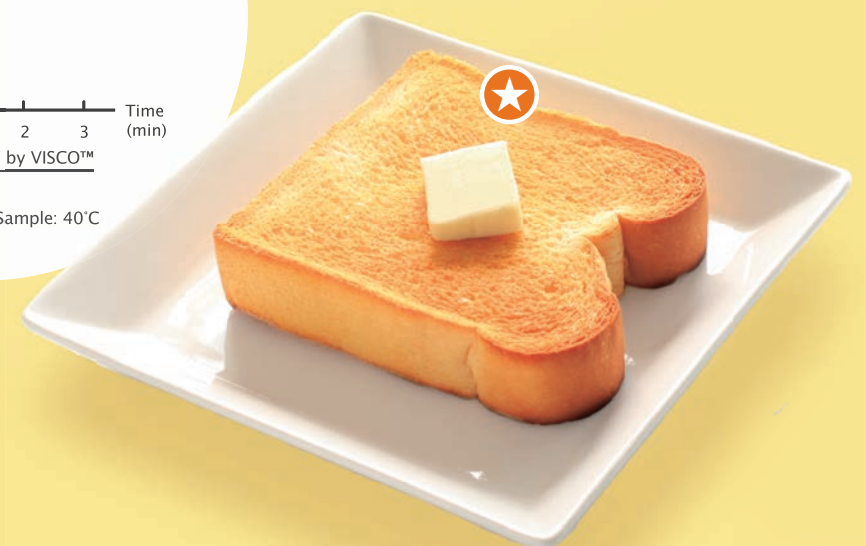
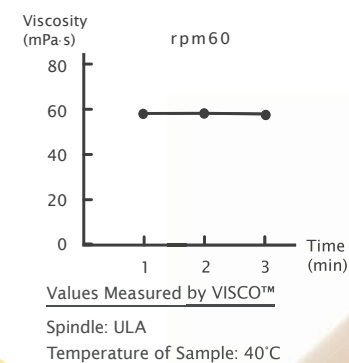

Quality Control of Butter

The PAL™-SALT is recommend to measure salt content. To measure the acidity of the milk the PAL™-BX|ACID91 is recommended For pH measurement the PAL™-pH is recommended.



Chocolate

Why does chocolate melt in your mouth?

Chocolate has the perfect balance of sweetness and bitterness. Chocolate is made by mixing crushed cocoa beans, cocoa butter, salt, milk, and other flavoring agents. The oil found in cocoa butter is of a composition that is not seen in other natural oils. It is sold below room temperature yet

when bit into melts at from 30–35 degrees, slightly lower than body temperature. Because this nature chocolate begins to melt when placed in the mouth. Many manufacturers use from 5–10% vegetable oil in chocolate in place of cocoa butter. But in other parts of the world any

chocolate that contains more than 5% vegetable oil is not considered chocolate. Chocolates viscosity, luster, hardness, aroma are all affected by the blend and type of raw ingredients which causes differences in taste and texture

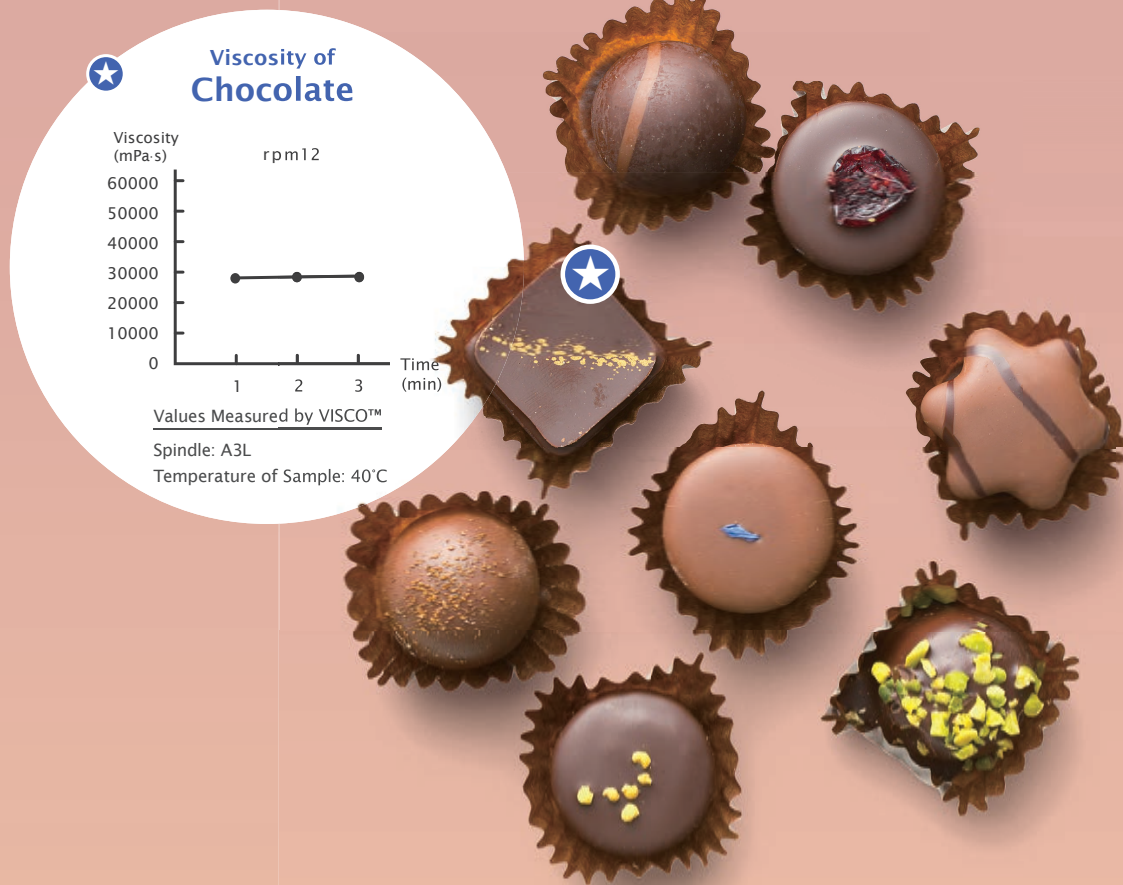

Customer comments

A manufacturer of chocolate, jellies and syrups, test the viscosity of their products at their research lab during product development and while testing new products. They chose the VISCO because of its portability.

Quality control of chocolate

As for refractometers the PAL™-Pâtisserie or RX™ series are recommended. To measure pH the PAL™-pH is recommended. To measure the conversion rate of sucrose the RePo™-3 is recommended.



PAL-Pâtissier RX™-5000i PAL™-pH RePo™-3

Beverages

Does the viscosity of beverages affect how it goes down the throat!?

Whether carbonated drinks on a hot summer day, a glass of tart 100% orange juice to beat fatigue, and unsweetened beverages when cutting back on sugar, there are many different types of beverages in the world.

A study published in the American Journal of Clinical Nutrition "Empty Calories and Phantom Fullness," they

compared two drinks of the same caloric and nutritional content with varying viscosity and found that viscosity determined one's fullness rather than the caloric or nutritional content.

Additionally, a journal published by The Japan Society of Cookery Science "Effects of Drink Viscosity on Nodogoshi" found that in addition to flavors tasted on the tongue, nodogoshi sensation of liquid passing through the throat is important and nodogoshi influences the likings.

Nodogoshi varies with age and it is known that younger age group prefers less viscous liquids whereas older age group tend to like more viscous liquids.

Furthermore, posture when drinking is said to influence how the viscosity is felt. Drinking with the chin up and head tilted as when one is drinking out of a bottle, versus drinking with a straw will feel differently as it goes down the throat. Even beverages that one may not think it has much to do with viscosity will have slight differences from one product to another.

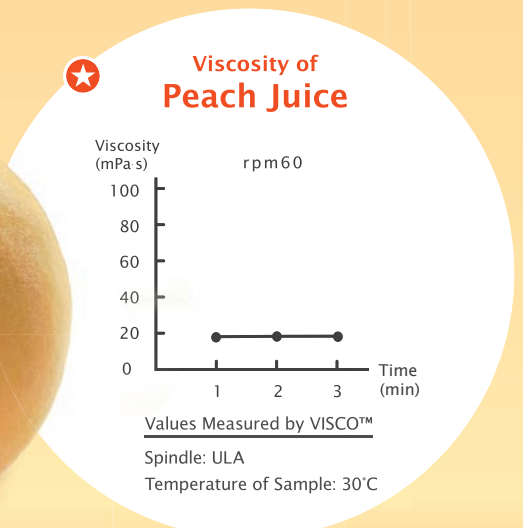

Customer comments

A manufacturer of various beverages and milk products who have been using ATAGO refractometers in their lab and field demonstrated VISCO™ as soon as it was released. They commented that they had never seen a viscosity meter that is so easy to use and can take stable measurements regardless of where the measurements are taken. They were also very impressed about its compact size.

Quality Control of Beverages

Concentration, salt content, pH, and acidity are important parameter for beverages. For concentration, the RX™ series or inline concentration meter is recommended. PAL™-SALT for salt content, and PAL™-pH for pH is recommended. To measure the acidity of citrus and other fruit juices a Brix-Acidity Meter is recommended.



RX™-5000i CM™-800α PAL™-SALT PAL™-pH PAL™-BX|ACID1

Okayu (Rice Porridge/Congee)

Rice porridge everyone loves: What is the Difference Between 30% or 100%?

Rice porridge, congee or okayu is a rice dish that is cooked in the same manner as the regular rice, but with a higher volume of water.

Rice porridge or congee has been loved by everyone. It is gentle on the stomach, prevents colds, and increases stamina and so on. Rice porridge is made not only for those that are sick but also as baby or care food.

Different types of rice porridge are defined by the amount of water added.

<Rice-to-water ratio>

- Zen-gayu- 1:5
- Shichibu-gayu- 1:7
- Gobu-gayu- 1:10
- Sanbu-gayu- 1:20

For example, when okayu is used for baby food, one would start with very runny okayu and gradually reduce the amount of water as the baby gets older. When taking care of a sick person, the thickness of the rice porridge is adjusted depending on their appetite and condition.

Also, with age, elderly may have difficulties swallowing food. To prevent aspiration, rice porridge is put in a mixer to make a paste like texture and a thickening agent is added. In recent years, due to the increase in the elderly population with dysphagia, research is currently underway, especially concerning the thickness of (viscosity and hardness) dysphagia friendly foods.



★ **Viscosity of Okayu**

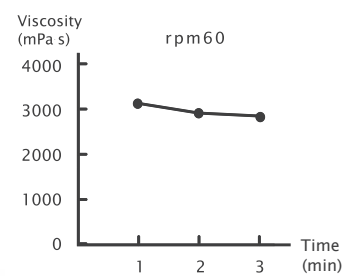

Values Measured by VISCO™
Spindle: A3L
Temperature of Sample: 30°C

Dysphagia Friendly Diet

In the recent years, with an aging society, dysphagia friendly food products are being developed. Dysphagia diets are meals for elderly that have difficulties chewing and swallowing where thickness and size are adjusted.

Viscosity control is very important when it comes to dysphasia diet as wrong thickness can be life threatening. VISCO™ is acknowledged in the nursing industry for its ease of use the kitchen by anyone.

Quality Control of Okayu (Rice Porridge/Congee)

PAL™-SALT is recommended for salt control. Instead of using uncooked rice, when okayu is made using cooked rice, G-50 can measure water content once the rice is done cooking. PAL™-pH is recommended to manage pH levels.



Frying Batter

Batter: A key factor that determines the texture and flavor of fried foods

Batters are made by combining some sort of flour with egg, milk and/or water and coat foods in a thick layer. When making batter at home, do you check its thickness by scooping the batter with

chopsticks? This is also a proper way of checking viscosity. Professionals check to make sure that the batter has good viscosity so that food would have good contact with the frying oil and proper

texture after fried. A viscosity of the batter is an important element and the deciding factor as to whether deep fried food has the crispy or crunchy texture.



★ **Viscosity of Frying Batter**

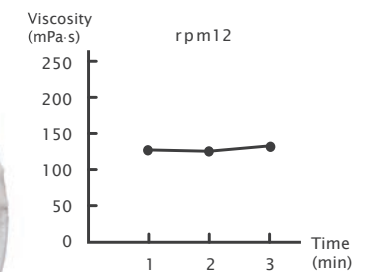

Values Measured by VISCO™
Spindle: ULA
Temperature of Sample: 30°C

Muginoho Co., Ltd.

Muginoho Co., Ltd operates franchise cream puff specialty stores called, "Beard Papa's Fresh and Natural Cream Puffs." Viscosity is measured for a consistent hardness of the pastry dough. In the pursuit of the perfect crunchiness upon first bite and smooth, creamy, taste in the mouth, Beard Papa's is very particular about their preparation methods and ingredients they use. To deliver fresh, light, creamy, and flaky consistency, Beard Papa's chose the VISCO™ for "potability" and "usability" that anyone can easily use onsite.

Katori Foods

Katori Foods has been manufacturing specialty handmade frozen foods for over thirty years. Katori Foods focuses on monitoring the frying batter when making fried foods such 'rolled katsu' (fried pork rolls) or tatsuta-age (fried chicken) and so on. If batter is too viscous, it will be too thick and heavy, resulting in customer complaints and when it is runny the layer will not adequately cover the food and ruin the taste.

Katori Foods was met with difficulties keeping viscosity managed as most viscosity meters cannot be used on the production floor and it is difficult to operate such instrument without prior knowledge. VISCO™ was able to offer solutions to these problems and because it is battery operated, it can take measurements anywhere. Katori Foods was extremely pleased with VISCO™'s capabilities. Giving a number to taste provides shortcut to employee training and ATAGO is very pleased that VISCO™ has been of such help.

Quality control of frying oil

The DOM™-24 is a popular unit that can measure acid value of frying oil. For more information, please contact ATAGO for a copy of our Perfect Oil Guide. As for testing the pH of batter, PAL™-pH is recommended.



Shampoo

Cleans the scalp and washes away excess oil

The primary purpose of shampoo is to clean the scalp and wash away any excess oils. It is important to wash thoroughly because when pores on the scalp become clogged, decreased metabolism will result in hair loss. The best hair washing tip is to massage gently making sure not to scratch the scalp.

The main ingredients of shampoo are water and surfactant with roughly 80% water and 10–20% surfactants. Conditioning agents, thickening agents, preservatives, and fragrances constitute about 1%. Surfactants or cleansing agents can be classified into three categories, amino acids, soaps, and high grade alcohol agents and it can further be separated according to its ingredients such as botanical, organic, non-silicone, and scalp.

Shampoos are made viscous for ease of handling. Viscosity allows appropriate amount of shampoo in the hand without spilling and it also creates lather. The viscosity of shampoo can also influence the shape of the bottle. Shampoo bottles with pump dispensers will require a larger nozzle diameter for viscous shampoos whereas, shampoo squeezed from cap style shampoo bottles will need hardness of the bottle, amount of force applied to the bottle, and appropriate viscosity to be in balance.

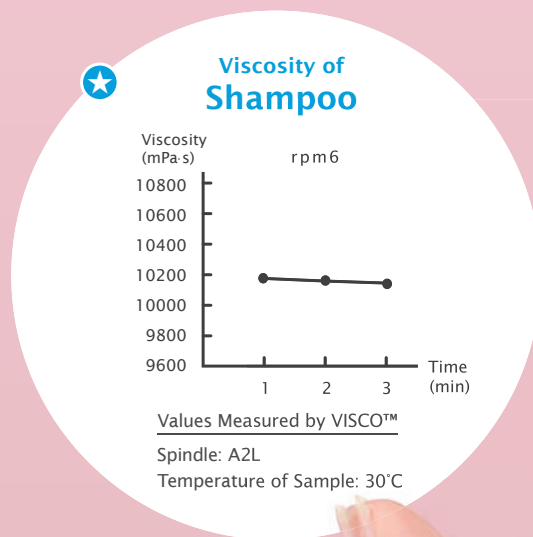

Conditioner

Helps to improve the condition of the hair

After shampooing the hair and scalp, most of us use, rinse, conditioner, or treatment cream. Amongst these, rinse was the first to be developed to smoothen the hair by neutralizing the alkaline soap.

Conditioners were developed to improve the condition of hair and it protects hair from dirt as well as making it softer and smoother. Treatment creams are used to repair hair damage by penetrating deep into hair, caring from the inside out.

Rinses and conditioners have low viscosity as it works on the surface of hair by coating the hair surface even after washed away. Treatment creams applied and left in the hair have high viscosity to penetrate deeply into the hair while remaining on the hair surface.

The viscosity of hair care products have a very strong relation with its effect.

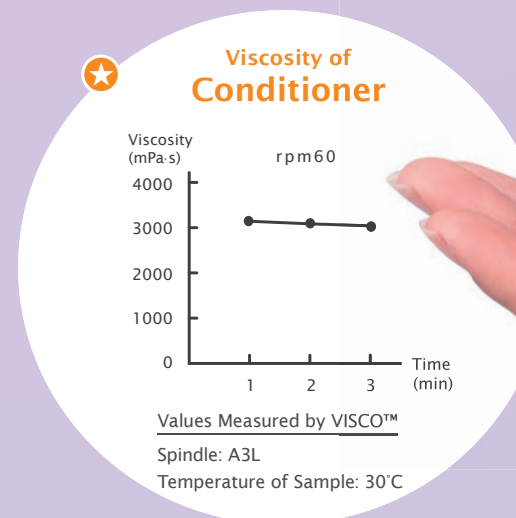

Horitech Co.

Horitech Co. is a small-lot contractor and OEM distributor of shampoos, facial lotions and other cosmetic products. At Horitech Co., VISCO™ is used to manage how well it comes out of the bottle, or how it spread on the skin. Their shampoo has many repeat customers and viscosity is important for those that buys the product for "its usual texture."

Prior to purchasing the VISCO™, Horitech Co. was using a B type viscosity meter, but because it required 500mL of sample per measurement, they have decided the switch to VISCO™ that only requires 15mL of sample and to save cost and cleaning time.

Quality Control of Shampoo

For managing the concentration of shampoos, the RX™ series or CM™ series is recommended and as for pH, the PAL™-pH is recommended.

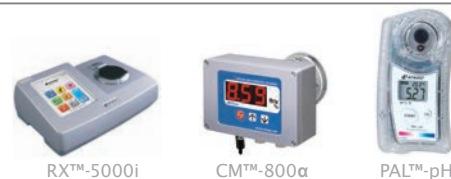

Quality Control of Conditioner

For monitoring the density of conditioner, the RX™ series or the CM™ series is recommended and for monitoring pH, the PAL™-pH is recommended.



Paint

The viscosity of paint is an index of how well it paints.

There are three purposes of paint- protection, aesthetics, functionality.

Protection: When metal and wood is exposed to wind, rain, and sunlight, it may rust or rot. The paint on the surface creates a coating layer that can act to preserve and protect it.

Aesthetics: There are many painted goods like cellular phones, cars, etc. around us. A coat of paint is aesthetically pleasing and gives color and shine.

Functionality: A coat of paint can provide heat insulation and/or resistance.

An important factor in making these roles fully demonstrated is viscosity. The viscosity of the paint is related to ease of application, finish and long-term stability of the paint.

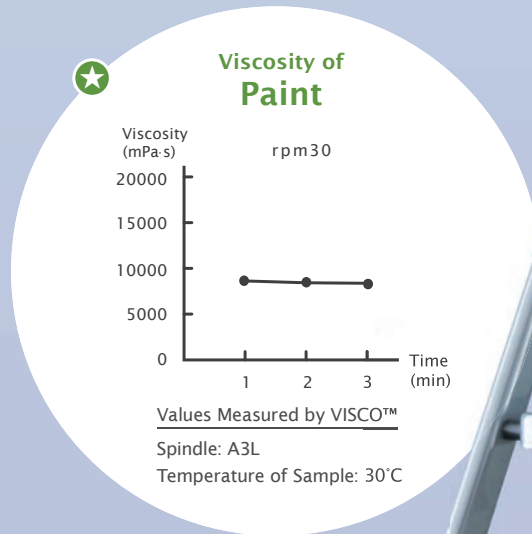

Neotec Co.

Neo Tech specializes in metal cutting and special surface treatment for automotive parts and molding and high-quality coating for medical device parts. Before purchasing a VISCO™, they were using a cup-style viscosity meter, but decided to switch to VISCO™ for more precise control.

Equipment and conditions of the coatings are separated according to the product. For example, medical coatings are often made into thin films, and the coating method is changed according to the viscosity of the coating material. The plant for manufacturing medical equipment and the plant for automobile parts are separate building, and the painting area spans several areas. In addition, they said that the ability to quantify viscosity, the simplicity of measurement method, and the stability of measurement accuracy were reasons for selecting VISCO™.

Customer comments

A manufacture of strippable paint used to prevent corrosion, protection, and repel water mixes their own blend of paint has decided to purchase VISCO™ after their customer complained about inconsistent viscosity. Neo Tech uses VISCO™ to numerically capture their product viscosity for improved and consistent viscosity. They are especially fond of the VISCO™ for accuracy, price, and connectivity to PC for data management.

Cleaning solution

The viscosity of cleaning solution directly relates to its cleaning power

There are many different types of cleaning solutions. Depending on the type of soils or stain, for example, water, glycol, hydrocarbon, alcohol, and chlorine base cleaning solutions each with distinct characteristics.

When choosing a cleaner, how well it can clean is one of the most important points. To increase cleaning power, it is important to enhance the absorption rate of the cleaner to the surface of the dirt and the key factor for absorption is surface tension and viscosity. A surface tension refers to fluid characteristic when it tries to decrease surface area. For it to penetrate soil better, decreased surface tension and low viscosity is necessary. Surface tensions are usually controlled by use

of additives such as surfactant and its concentration. As for viscosity, in some cases, high viscosity is desired to keep the cleaning solution on the stain long. High viscosity lowers how much it penetrates beyond surface, but depending on the use of the cleaning solution, there is a proper balance. In the world of cleaning solutions, density and viscosity are managed and adjusted depending on the use of the product in order to have a high level of cleaning power.

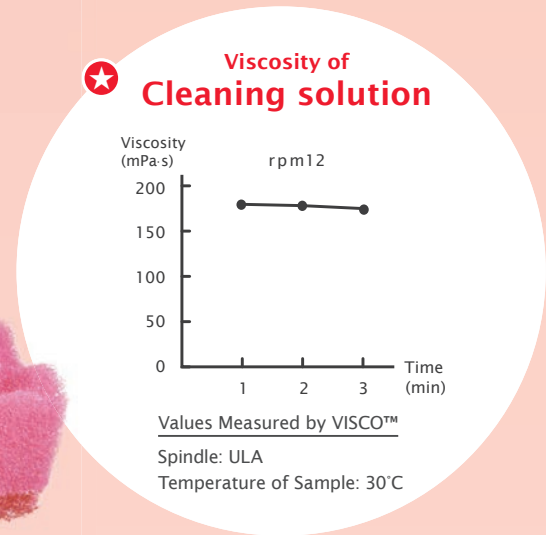

Customer comments

A manufacture of cleaning solution tests the viscosity when purchasing the raw materials. Viscosity is checked every time the materials are received. For this reason, they chose the portable VISCO™ for its portability and ease of use on site. Additionally, the product development team is also using the VISCO™ to study the correlation between viscosity and cleaning power.

Quality Control of Paint

A refractometer is used to check the properties of the organic solvent used to dilute the paint. The portable PAL™-RI or RX series are recommended for high accuracy lab readings. To measure the pH of the paint, the PAL™-pH is recommended.



Quality control of cleaning solution

Cleaning solution will become increasing dirty over time. A concentration meter is essential to check how dirty it is. For a portable type, the PAL™-Cleaner is recommended. For higher spec measurements in the lab, the RX™ series or if one wants continuous measurements on the line the PAN™-1 or CM™-800α is recommended. For pH, the PAL™-pH is recommended.



Engine oil

Accommodating various driving conditions

Engine oil is a lubricating oil used in the engine. Normally engine oil is located in an oil pan below the engine and is drawn up into different parts of the engine using a pump. The main role of engine oil is said to help lubricate, keep the engine cool and air tight, disperse detergents, and prevents rust in the inner parts of the engine. The viscosity

of engine oil characteristically changes with temperatures so is designed to handle many different driving conditions. For example, at colder temperatures, the viscosity of the engine oil helps start engine smoothly, and in parts of the engine that are high temperature where more stress is placed on the engine, the increased viscosity helps to protect the engine and also get the most out of the lubricant effect of the oil. There

are many different variations of these temperature vs viscosity relationships of engine oils. For ecological cars, where the engine power low and the fuel efficiency are the focus, relatively low viscous all-season motor oil is recommended by the manufacturers, whereas higher viscosity motor oil is recommended for sports cars with a high-power engine that are designed to get the best possible performance out the engine. Engine oil and viscosity have a close relationship and it is controlled by strict quality control.



Viscosity of engine oil

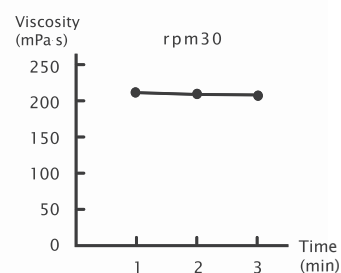

Values Measured by VISCO™
Spindle: A3L
Temperature of Sample: 29.5°C

Engine oil and viscosity standards

As a representative of an engine oil viscosity standard, there is the SAE standards. This is a standard that was set by the American Society of Automotive Engineers. For example, 5W-30 denotes the viscosity of the oil at low and high temperatures respectively. The 5W is the viscosity at low temperature and the W means winter which represents the viscosity during winter months. The lower the number the more viscous the oil is, even during cold temperatures. This means even at colder temperatures the higher viscous oil will allow for better engine performance and gas mileage. The last set of number indicates the viscosity at high temperatures. The higher the value, the engine oil will remain hard even at high revolution rates so is fit sports cars.

Quality control of Engine oil

A refractometer is used to check the raw materials of the engine oil. As for a portable type, the PAL™-BX/RI or the PAL™-RI is recommended. If using in the laboratory and one wants high spec measurements, the RX™ series is recommended. For monitoring pH the PAL™-pH is recommended.



PAL™-BX/RI



PAL™-RI



RX™-5000i



PAL™-pH

Thickening agent

Thickening agent is used in a wide variety of goods for foods, pharmaceuticals and industrials.

One will see by looking at the labels of many common products such as medical products, senior foods, cosmetics, adhesives, polymers, and paints that thickeners are used for many different types of products. Thickening agents are called three different names depending on its purposes. When it is in a small amount, but highly viscous, it is labeled as a thickening agent. When used

to thicken a liquid or jelly, it is known as gelling agents. If it is used to increase and stabilize the thickness of a food, it is known as a stabilizer. For example, when it is used for medical use, stabilizers are used to suspend the active ingredients where it needs to stay. Specifically, by having a certain viscosity, eye drops for example, when applied, thickeners will keep the medicine from dripping out of

the eyes and also help the medicine spread evenly. Also, in the medical field, for those that have trouble swallowing, adding thickeners can make it easier for patients to eat.



Viscosity of Thickening agent

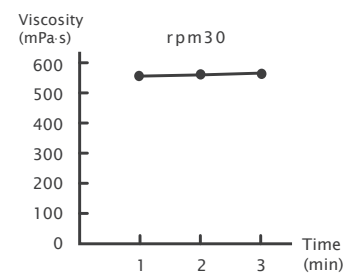

Values Measured by VISCO™
Spindle: A3L
Temperature of Sample: 29.5°C

Demlite Co., Ltd.

Demliete Co., Ltd. measures viscosity during production process to check the swelling of the raw materials used for cosmetic, cleaning agent. The materials used for cosmetics and cleaning agent can increase in viscosity during production and optimal viscosity varies depending on products. For this reason, choosing the right viscosity is very important. Once past the optimal viscosity, it is not reversible. Demlite Co., Ltd chose VISCO™ for its portability and ease of use on the production floor.

Quality control of Thickening agent

To measure pH of thickening reagents, PAL™-pH is recommended.



PAL™-pH

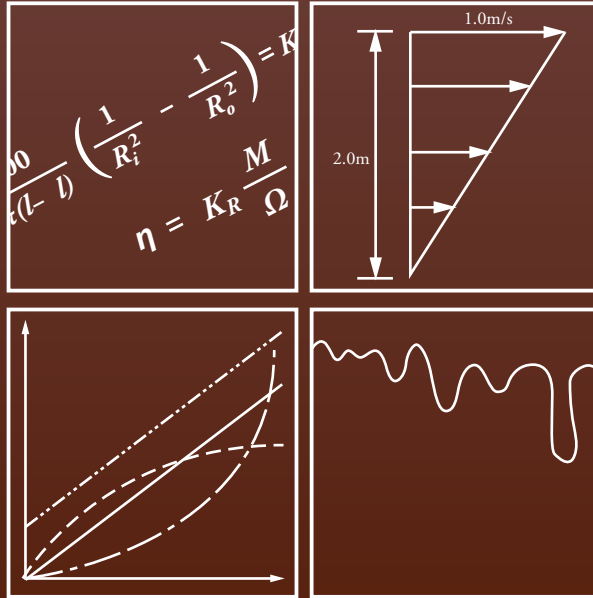

Viscometer Guide

For Sure and Easily Manage Viscosity

What is Viscosity	B4
Viscosity Around Us	B6
Newtonian and Non-Newtonian Fluids	B8
Viscometer of the World	B12

Product Information	B14
VISCO™	B16
VISCO™-895	B16
Methods of Measurements	B20
8 Features.....	B22
Package	B26
VISCO™ B(L)	B34
Methods of Measurements	B40
6 Features	B42
Water Jacket (for 500mL Beaker)	B44
FAQ.....	B50
Implementation Results	B52

All ATAGO products are designed and manufactured in Japan.



<http://www.atago.net/> overseas@atago.net

Headquarters: The Front Tower Shiba Koen, 23rd Floor
2-6-3 Shiba-koen, Minato-ku, Tokyo 105-0011, Japan
TEL : 81-3-3431-1943 FAX : 81-3-3431-1945



HACCP GMP GLP

ATAGO products comply with HACCP, GMP, and GLP system standards.

ATAGO U.S.A., Inc.	TEL : 1-425-637-2107	customerservice@atago-usa.com
ATAGO INDIA Instruments Pvt. Ltd.	TEL : 91-22-28544915, 40713232	customerservice@atago-india.com
ATAGO THAILAND Co., Ltd.	TEL : 66-21948727-9	customerservice@atago-thailand.com
ATAGO BRASIL Ltda.	TEL : 55 16 3913-8400	customerservice@atago-brasil.com
ATAGO ITALIA s.r.l.	TEL : 39 02 36557267	customerservice@atago-italia.com
ATAGO CHINA Guangzhou Co., Ltd.	TEL : 86-20-38108256	info@atago-china.com
ATAGO RUSSIA Ltd.	TEL : 7-812-777-96-96	info@atago-russia.com
ATAGO NIGERIA Scientific Co., Ltd.	TEL : 234-707-558-1552	atagonigeria@atago.net
ATAGO KAZAKHSTAN Ltd.	TEL : 7-727-257-08-95	info@atago-kazakhstan.com

* Specifications and appearance are subject to change without notice.

Copyright © 2020 ATAGO CO., LTD. All rights reserved. ENV.01 20032000GR Printed in Japan

Viscosity is a quantity expression of viscousness

There are liquids that are silky and smooth like water, and neba-neba (slimy/sticky) liquid like honey. The degree of this smoothness or stickiness is called viscosity.

For Example

Tonkatsu, or deep fried pork cutlet sauce is about 600 times more viscous than water and honey is about 1300 times more viscous than water. When a cup filled with tea and honey are poured out, low viscous tea flows out at once, but highly viscous honey won't flow out easily.



memo

An Instrument Used to Measure the Viscosity is a "Viscometer"

There are several different types of viscometers. We offer a wide range of rotational viscometers. A rotational viscometer converts the rotational resistance on the rotating spindle (rotational resistance) to viscosity measurements.

For further details pg. B12



Units of Viscosity

Pa.s	mPa.s	cP
0.001	1	1

Viscosity and Temperature

The viscosity varies with temperature changes

As temperature increases, viscosity decrease. For example, the same honey at high temperature may have lower viscosity.

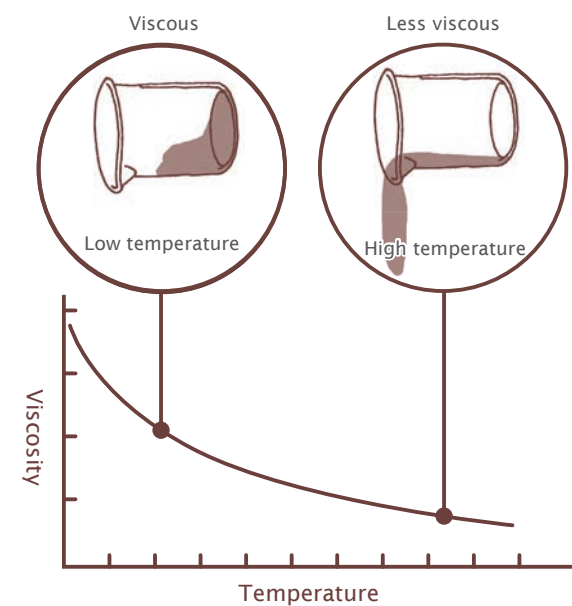

Kinematic Viscosity

A measure of the resistive flow of a fluid

Viscosity is the measure of a substance's resistance to motion, whereas, kinematic viscosity measures the resistive flow of a fluid of a substance. The viscosity acts as a brake against the flow, but the effectiveness of the brake depends on the density of the fluid. When the same strength of brake is applied to a bus and a bicycle traveling at the same speed, they will both come to stop differently because the weight is different. Kinematic viscosity can be calculated by dividing the viscosity by density. The unit of kinematic viscosity is [m²/s].

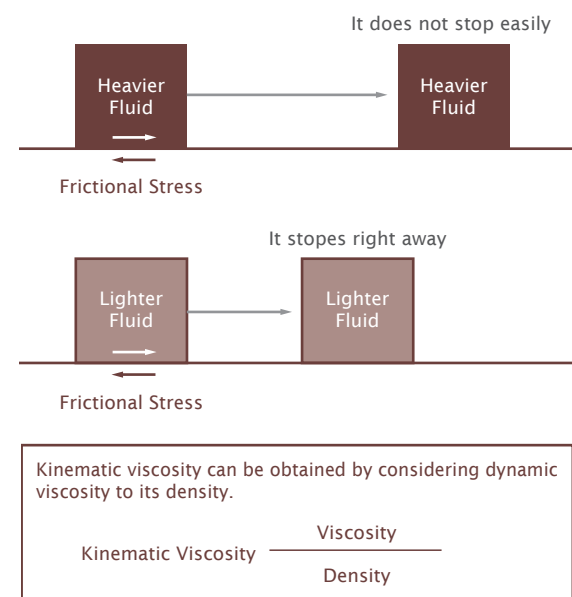

Examples of Viscosity



Viscosity is an important component for various industries

For Example

We will start by using everyday food as an example. People perceive flavor by fully activating various sensors such as taste and texture. In particular, mechanical properties such as hardness, elasticity, and viscosity of foods that are expressed as sticky, soft and chewy, or fluffy are considered important factors that determine the taste.



Viscosity strongly relates to taste, ease of use, function, and effectiveness

e.g. 1 Noodles
Koshi, or an al dente or firm-bite consistency, is a vital component in deliciousness

Koshi is a commonly used term for noodles. It is a gluteneous viscoelastic texture that is created when the ingredient of noodles, water is added and kneaded. The fact that having al dente or firm-bite texture contributes to how we perceive flavor, this is one of a good example of how viscosity is an important factor.



e.g. 2 Beer
Enjoy Nodogoshi, or how food or drink goes down one's throat

The word nodogoshi is sometimes used to describe the deliciousness of beer, and it is also related to viscosity.



e.g. 3 Cream
Skin type and moisturizer

The texture is called the feeling and texture of cosmetics, milk, and body creams. Dry skin prefers moist texture, and oily skin tends to prefer something that is smooth. The viscosity is greatly related to the comfort.



e.g. 4 Detergent
Increased viscosity strengthens the work of adhesion

Think of bathroom cleaners. There are toilet bowl cleaners that you pour into the toilet, leave it for 2 to 3 minutes and flush the toilet requiring no scrubbing. When viscosity is increased, the detergent clings to the entire toilet bowl and coats dirt effectively. Viscosity contributes greatly to cleaning power.



Viscosity have different characteristics depending on different substances

Q Which is more viscous, honey or butter?

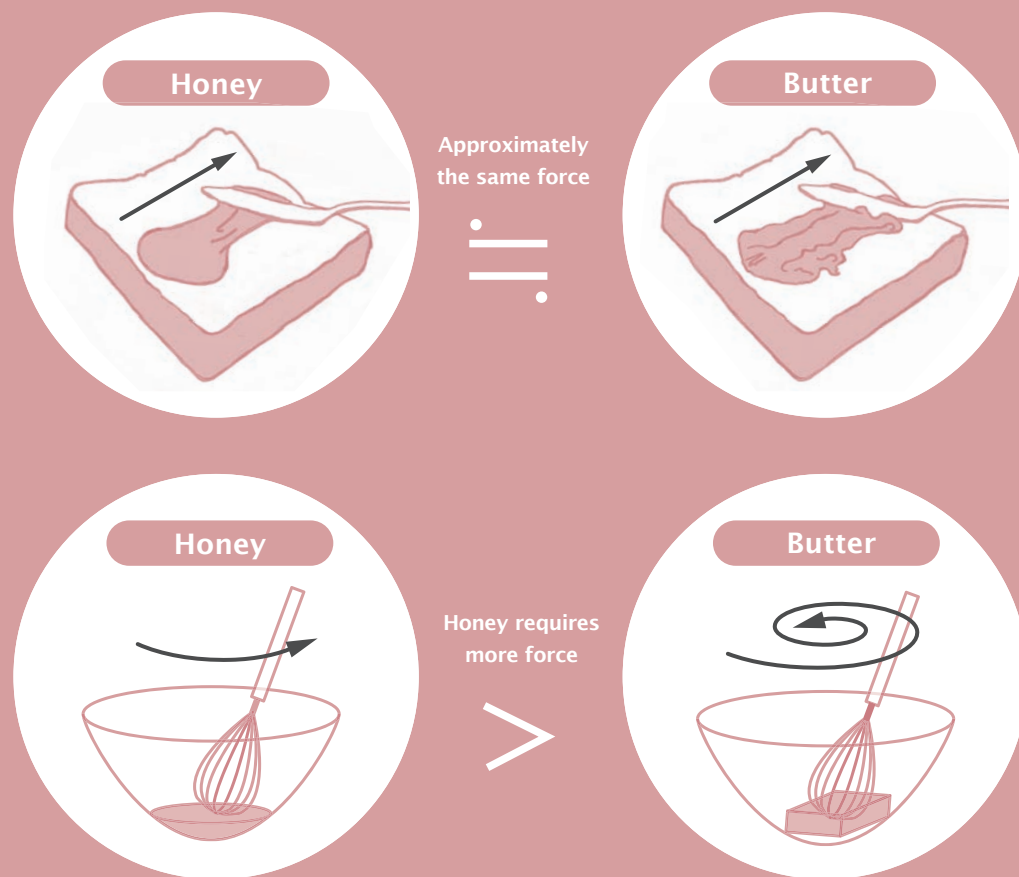

When you spread some butter or honey on a toast, you apply about the same force. On the contrary, when each one is stirred in a bowl, the butter can be stirred with a relatively small force, but honey requires more force.

A Neither viscosity can be said to be high or low. Why is that? That is because the viscosity of butter is changing as the force is applied.

A fluid in which the viscosity does not change with the applied force, as in the case of honey is referred as a "Newtonian fluid" and a fluid that changes the viscosity when force is applied, like a butter, is called "non-Newtonian fluid."

In general, when a substance is a pure substance, most of them are more likely to be a Newtonian fluid. A mixture of 2 or more different substances is most likely to be a non-Newtonian fluid.

Newtonian Fluid

Applied force does not affect viscosity

Water, honey, cooking oil, mizumame (Japanese sweetener), aqueous sugar solution, aqueous salt solution, alcohol, etc. are Newtonian fluids.



Non-Newtonian Fluid

Applied force changes viscosity

Butter, ketchup, mayonnaise, yogurt, etc. is non-Newtonian fluids.



There are three categories within non-Newtonian fluids.

A Bingham plastics, pseudoplastic fluids, and dilatant fluids.

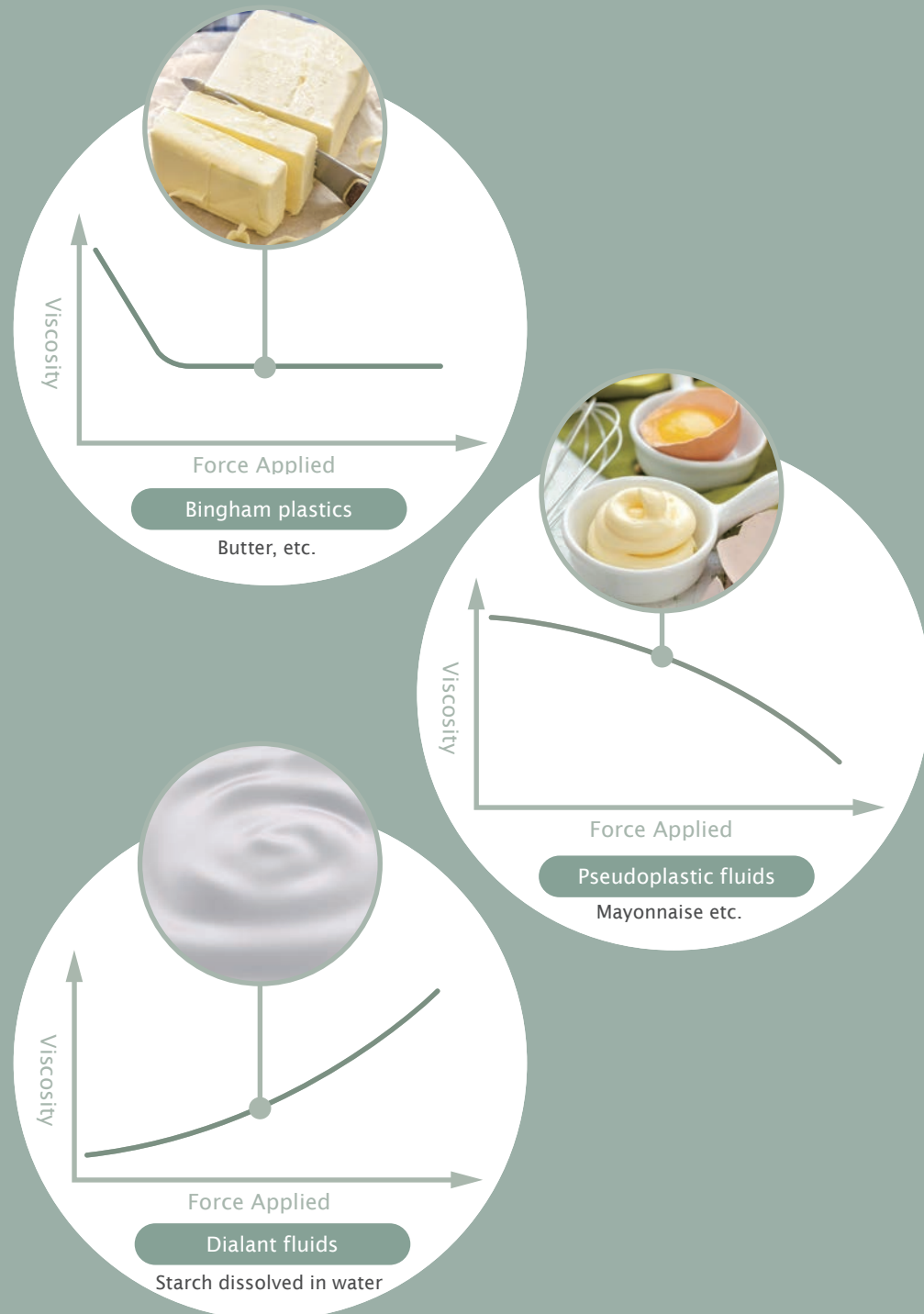

1 Bingham plastics
A material that behaves as a rigid body at low stress, but flows as a viscous fluid at high stress.

Butter can be applied to a toast by applying force with a knife, but it won't move unless you apply a certain amount of force. The force required to spread this butter is called yield stress, and its value is called the yield value.

"Bingham fluid" is a "plastic fluid" that exhibits a certain viscosity, such as Newton fluids, when it flows out while having a yield value.



2 Pseudoplastic fluids
A material that decreases in viscosity when force is applied

When the viscosity of material decreases by applying force is called a "pseudoplastic fluid". It is highly viscous until the force is applied and may appear to be Bingham fluid, but does not have a yield value. Examples are familiar foods around us that are found in tube containers, such as mayonnaise and ketchup, are pseudoplastic fluids.

In addition, there is a fluid called thixotropy^{*1}, a fluid that exhibits a behavior similar to a pseudoplastic fluid.



3 Dilatant fluids
Viscosity increases as force is applied

In contrary to pseudoplastic fluids, a dilatant fluid is a fluid that increases viscosity by applying force. Typical examples are 1:1 ratio of starch and water mixture. It flows like water, but when it is stirred fast, it hardens and stops flowing out.



***1 memo**
Thixotropy
Viscosity changes not only by applying force, but also over time

The fluid that indicates thixotropic characteristics have low viscosity when force is applied. In this respect, thixotropic and pseudoplastic fluids appears to be similar, but the difference between pseudoplastic fluids is not only the force applied, but also the viscosity changes over time. Thixotropy reduces viscosity by adding a certain amount of force, but its property returns to its original state when left for a certain period of time with a reduced viscosity. For instance, when paint is stirred, its viscosity is reduced making it easier to painting on the wall with a brush or roller. Stiring before painting is not only to eliminate color unevenness, but also to bring out the thixotropic characteristics that can increase workability. Because no force is applied to the paint immediately after application, the viscosity increases and it dries without dripping down.

The ideal paint, which is "easy to paint and hard to drip", makes good use of the properties of thixotropy.

Viscometer, There are Many Different Types of Measurement Methods.

For Example

Under JIS Z 8803, the Japanese Industrial Standard, viscometers are classified into capillary viscometers, falling ball viscometers, rotational viscometers, and vibrating viscometers. There are other device that measures viscosity such as viscosity cups and LST.

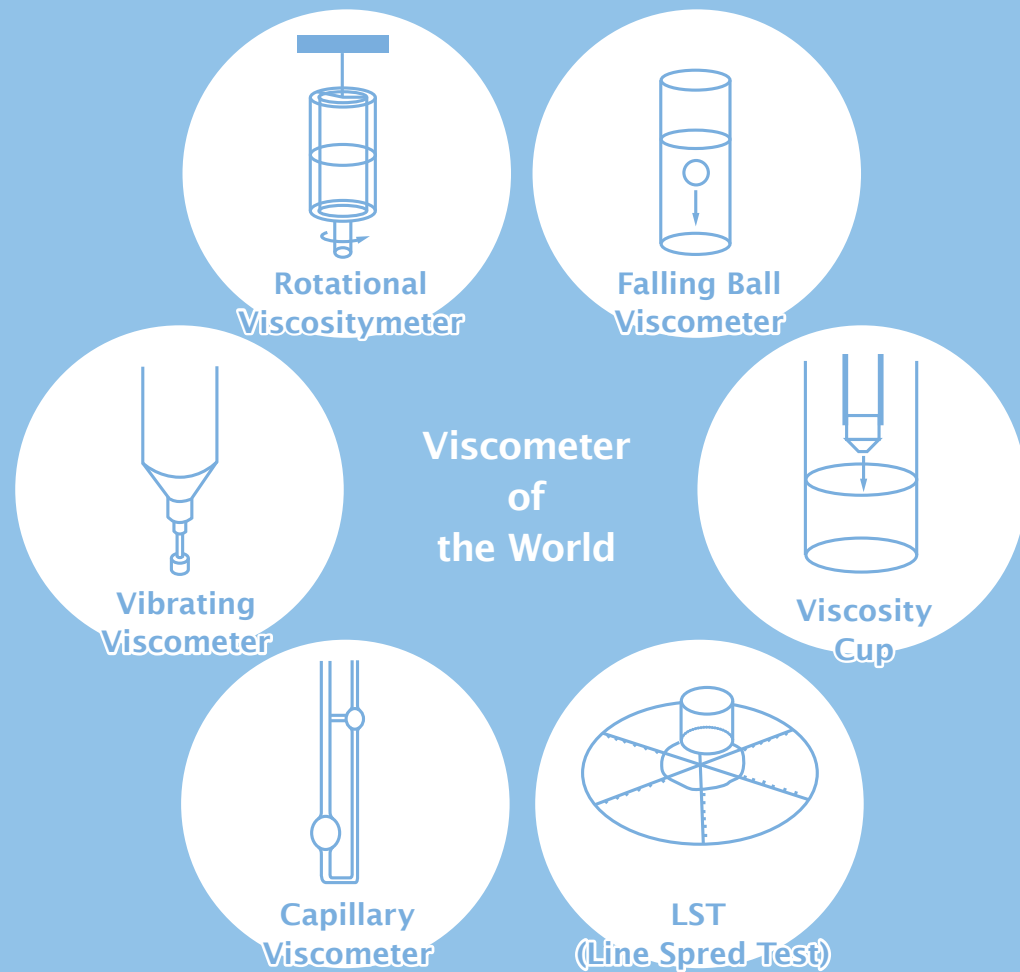

memo

ATAGO's viscometers are a rotational viscometer.



Rotational Viscositymeter

It is one of the most commonly used viscometer. The structure is simple, easy to use, and the measurement range is wide and can be measured with high accuracy. The viscosity is determined by measuring the torque (shear stress) acting on the cylindrical surface when a cylindrical rotor is placed in the sample and rotated at a constant speed. Depending on the type of rotor, there may be a co-axial double cylindrical type, a single cylindrical type, a cone plate type, etc.

B Type Viscometer

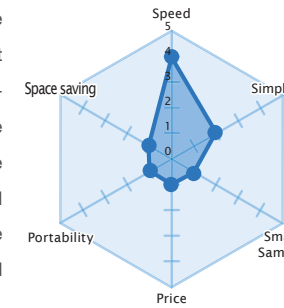

VISCO™ (ATAGO Viscosity meter)

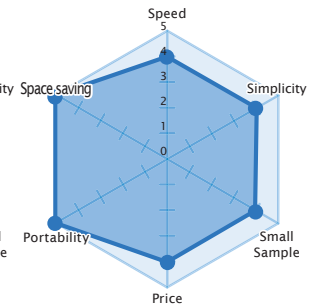

The cone plate type can determine the flow characteristics of non-Newtonian fluids by changing the rotational speed.

Capillary Viscometer

Capillary viscometer is a kinematic viscosity that measures the flow time through the sample in the tubules. The viscosity can be calculated from the density of the sample (kinematic viscosity = viscosity/ density). It can be measured with relatively high accuracy for Newtonian fluids.

The price is also inexpensive and has been used for a long time, but it is a thin tube, and cleaning is complicated that can put a burden on the worker.

Usage: Petroleum and pharmaceutical products.

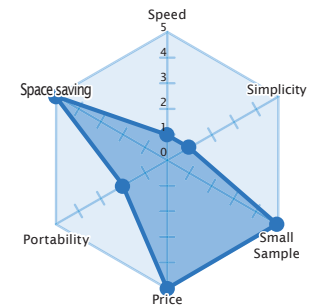

Falling Ball Viscometer

The ball is dropped in the sample, and the fall time is measured to determine the viscosity. Because the ball in the sample receives fluid resistance, the fall rate varies depending on the viscosity of the sample.

The viscosity of Newtonian fluids can be measured with high accuracy, for low viscosity samples such as water to high viscosity samples like oils.

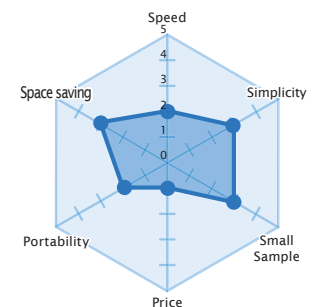

Vibrating Viscometer

It measures the viscosity by immersing the vibrating piece in the sample and vibrating at a constant frequency.

It is used as a process meter because the response is fast and continuous measurement is possible, and it can be measured while the liquid is flowing.

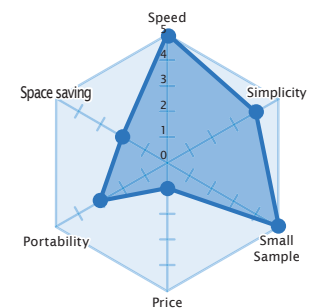

Viscosity Cup

The sample is filled in a metal cup, and the sample is exiting from the orifice (pores) at the bottom of the cup. The outflow time is measured to determine the viscosity. The outflow time of the sample from the orifice is usually measured by the stopwatch.

Usage: Paint and industrial oil (it is rarely used in food industry).

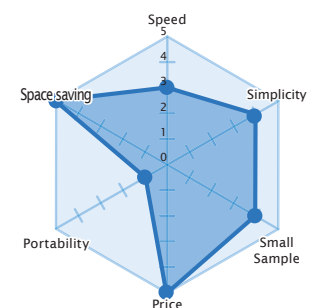



VISCO™

Free your customers from the hardships that were taken for granted
Anyone can enjoy and enjoy taking viscosity measurements
The New Viscometer

PRODUCTS

VISCO™

Measurement range 1 to 350,000,000mP-s, 1 to 350,000,000cP



Photo Left: VISCO™ Front
Photo Right: VISCO™ Back

1344031, 1553531(JPN)
ZL 2015 3 0418745.5(CHN)
D176013(TWN)
US D796,362 5(USA)

30-0888538(KOR)
No 002906149-0001(EUIPO)
53070(IND)
Patent Granted in countries around the world.

Product lineup

VISCO™
Housing:SUS, Aluminum, Legs, and Stand & Screw:SUS
Weight:1.2kg(main unit only), Stand +screw:0.5kg

VISCO™-895 **NEW**
Housing:SUS, Aluminum/Legs, and Stand & Screw:SUS
Weight:895g(main unit only), Stand +screw:275kg

Specifications

Cat.No.	VISCO™	6800	
	VISCO™-895	6820	NEW
Measurement range	A1	50 to 200,000mPa-s , 50 to 200,000cP	
	A2	100 to 600,000mPa-s , 100 to 600,000cP	
	A3	500 to 2,000,000mPa-s, 500 to 2,000,000cP	
	Torque	0.0 to 100.0% (recommended torque: 10.0 to 100.0%)	
	Temperature	10.0 to 40.0°C, 50.0 to 104.0°F	
Resolution	Viscosity	lower than 100mPa-s	:0.01mPa-s
		100mPa-s or higher lower than 10,000mPa-s	:0.1mPa-s
		10,000mPa-s or higher	:1mPa-s
	Torque	Lower than 10%	:0.01%
		10% or higher	:0.1%
		Temperature	0.1°C/0.1°F
Measurement Accuracy	Viscosity	±1% of Maximum Viscosity	
	Temperature	±0.2°C/±0.4°F	
Speed	0.5 to 250rpm		
	Number of Speeds: 20 levels		
Ambient Temperature	10.0 to 40.0°C / 50.0 to 104.0°F		
Environment Temperature	10.0 to 40.0°C		
Computer Communication	Output: USB - PC		
Battery Life (Approx.)	Approx. 7 hours (continuous operation at 60rpm)		
Power Supply	LR6 / AA alkaline batteries (x4)		
	AC adapter input AC100 to 240V. 50/60Hz, 0.3A output 9V, 0.5A.		
Materials	VISCO™	Housing:SUS, Aluminum/Legs, and Stand & Screw:SUS	
	VISCO™-895	Housing:SUS, Aluminum/Legs, and Stand & Screw:SUS	
Dimensions & Weight	VISCO™	12×12×20cm, 1.2kg(main unit only), Stand +screw:0.5kg Small volume beaker attachment: 0.1kg	
	VISCO™-895	12×12×20cm, 895g(main unit only), Stand +screw:275kg Small volume beaker attachment: 0.1kg	

*The above specifications apply only to measurements taken using the standard accessories.



VISCO™ was awarded Bronze "IBO 2016 Industrial Design Awards" for "Portable Analytical Instrument Design" by Bioinformatics, Strategic Directions International. VISCO™ was awarded for excellence in its functionality and industrial design.

PRODUCTS

VISCO™



Package Contents

VISCO™ and VISCO™-895

1	Main unit	1
2	Stand	1
3	Spindles (A1, A2 and A3)	one each
4	Temperature sensor	1
5	Small volume beaker attachment	1
6	S Beaker (15mL)	1
7	L Beaker (100mL)	1
8	AC adapter	1
9	USB Mini-B cable (1m)	1
10	1.5V AA alkaline batteries	4
11	Instruction manual	1
12	Inspection certificate	1
13	Spindle stand	1
14	Protective cap	1
15	Carrying case	1
16	Viscosity standard liquid*	1



* One bottle of viscosity standard liquid 200, 500, or 1000 is included. Select one when ordering. For further details, refer pg. B46. Contact ATAGO for other viscosity standard liquid.

6 7

15mL and 100mL beakers are included.

BeakerL(100mL)

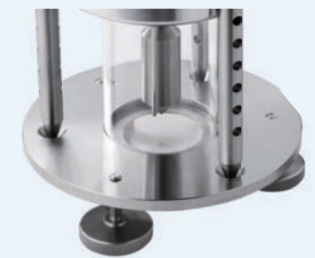

BeakerS(15mL)

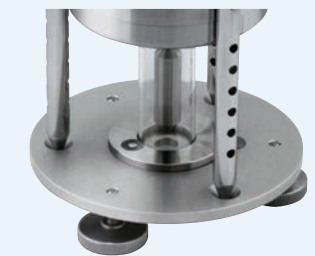

How to use

VISCO™

Setup



Power ON

Press the dial button
Press



Startup Screen → Main Menu Screen

Level Check

From the main menu
Select "Level"



Rotate the main unit's legs
Position it upright

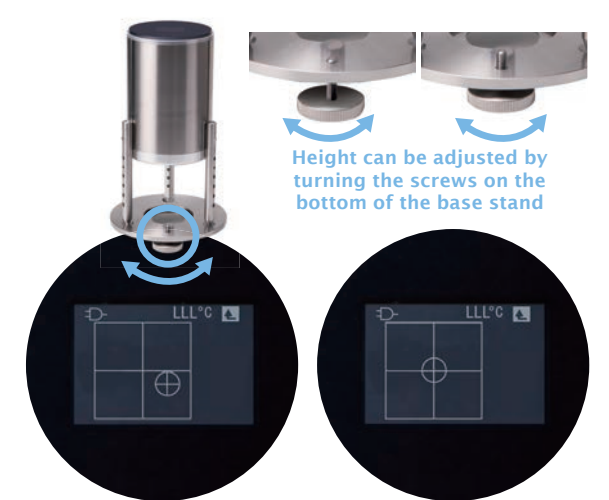

Not leveled

Leveled

Setup

Spindle and temperature sensor
Attach

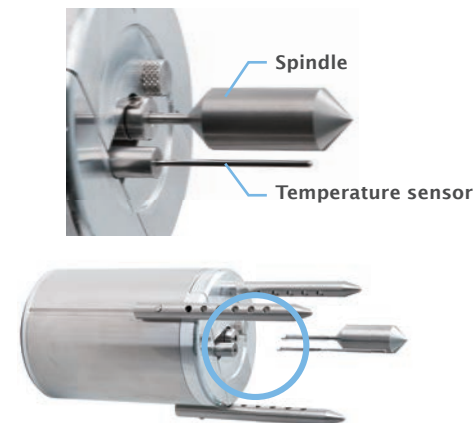

Beaker Setup

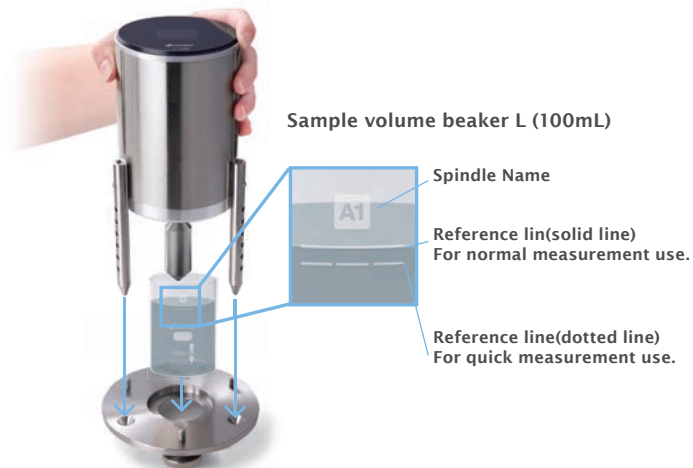

Measurement

From the main menu
Select "Measurement"



Spindle/Beaker/Speed Settings
Press "START"



QUALITY

8 Reasons Why VISCO™ is Chosen

A rotational viscometer that is used worldwide. VISCO™ is a rotational viscosity meter, but it looks a little different than the traditional viscometers. What is the difference?

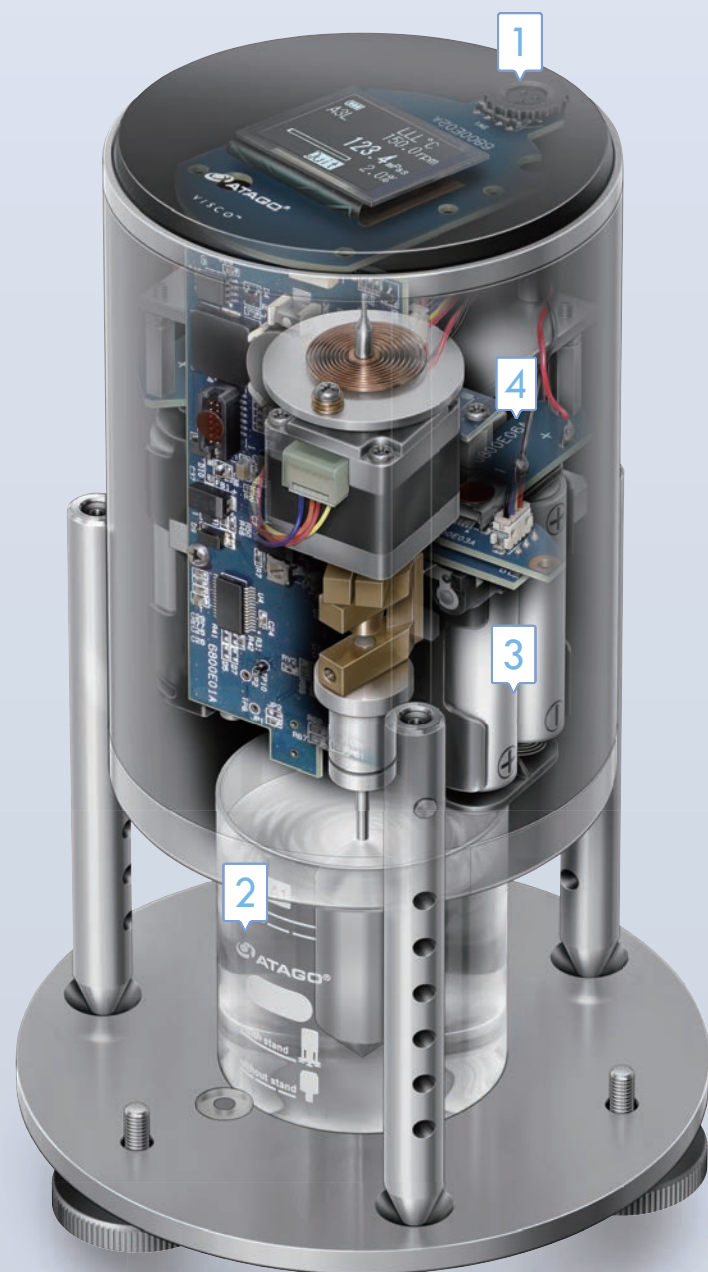

1 Simple Operation

VISCO™ offers extremely comfortable operation compared to B type viscometers. Only one button is needed for operation.

2 Remarkably Small Sample Volume

The B-type viscometer required a sample of 500mL for measurement, but the VISCO™ can be measured in small samples of 100mL or 15mL. This can minimize sample volume of valuable samples. It is also effective for measuring expensive samples because it reduces running costs for viscosity measurement.

Many samples are viscous, and cleaning after measurement takes time, but the reduced amount of samples makes cleaning easier and increases productivity.

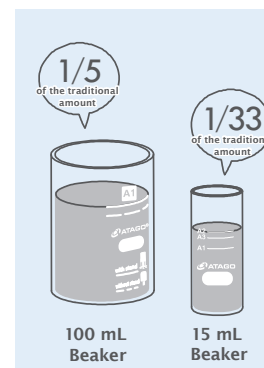

3 Battery Powered

Battery power allows VISCO™ to take viscosity measurements without worrying about where the power supply is. Since it is possible to continuously use for seven hours on battery power, you can use it at ease "anywhere" and in "any situation." * AC power supply is also included as standard.

4 Digital Level Adjustment

Rotational viscometers cannot measure viscosity sufficiently unless the equipment is installed horizontally.

The B-type viscometer was visually adjusted using a horizontal instrument, while the VISCO™ enables digital level adjustment for more accurate judgment than visually adjusting by incorporating a gyroscope sensor.

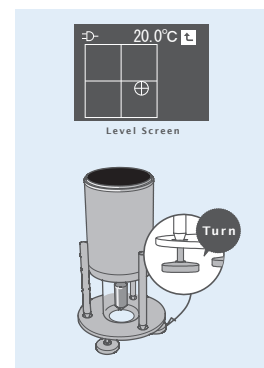

5 Cost Performance

In addition to adding value to the functional aspects, a price range is set at a point where it is easy for anyone to purchase.

QUALITY

8 Reasons Why VISCO™ is Chosen

Great ingenuity and user-friendly features

< Measurement screen >

Measurement values are displayed large

- 1 Viscosity
- 2 User Scale
- 3 Power Supply Indicator/Remaining Battery Charge Indicator
- 4 Auto Stop
- 5 Spindle/Beaker
- 6 Temperature
- 7 Return
- 8 Speed
- 9 Torque %



Dimensional drawing

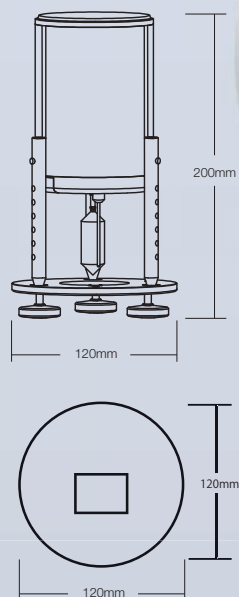

6 Light Weight and Compact Design

The VISCO™ is a compact and lightweight of 895 g to 1.2 kg*1 viscometer that can be carried anywhere and it can be setup where space is limited. There is no need to buy multiple viscometers, but one VISCO™ can be carried in a lab or in the manufacturing field. It frees you from cumbersome conversion tasks from one viscometer types to another. There is no financial burden because you only need one VISCO™.

*1VISCO™-895:895g, VISCO™: 1.2kg

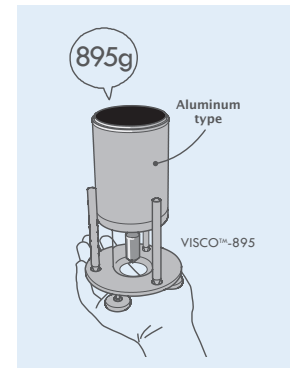

7 Enhanced Features

(1) Auto stop function

Some samples are called non-Newtonian fluids, and measurements are not stable at the beginning. For example, if the sample measurement is known to stabilize after 10 minutes from the start, the operator will have to stay put on the spot for 10 minutes until it stabilizes. With the auto-stop function, measurements will automatically stop after 10 minutes and the measurement is displayed. It is a function that can effectively utilize the manpower of those that take measurements.

(2) User scale function

By using this function, the measurement from VISCO™ can be set to match the value measured by Type B viscometer. One of the many reasons customers hesitate to update their instrument is that they cannot discard their previous measurements. The user scale function allows to offset previous measurements. When you enter three viscosity values measured with VISCO™ and three viscosity always measured by a conventional B-type viscometer, the built-in software calculates and automatically applies the conversion formula.

(3) Moving average function

It is equipped with a moving average function to display the average value of the last five minutes. For example, for very low-concentration samples, continuous measurements may not show stable measurements. In such cases, it is possible to show stable measurements by turning on the moving average function on.

8 Disposable container

The use of disposable containers has been made possible. A dedicated cup adapter allows the use of 90mL paper or plastic cups. The B-type viscometer was difficult to use in food production sites where glass containers were prohibited, but disposable containers can solve the problem.

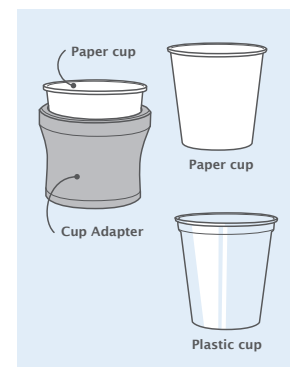

VISCO™ Package

With package A, disposable containers can be used instead of the beakers and package B is available for low viscosity sample measurements



Package Plan Suggestions

Package A Attach a paper cup or a plastic cup and a cup adapter to the stand.

Don't take glass products to the production floor again.

As long as it fits the cup adapter, other disposable cups besides what is included can be used. This makes taking measurements possible where the use of glass products are prohibited.

VISCO™ Package A Cat.No.6810

VISCO™ Main Unit (accessories included)
Cup Adapter (with 100pcs cups):RE-78141

VISCO™-895 Package A Cat.No.6830

VISCO™-895 Main Unit (accessories included)
Cup Adapter (with 100pcs cups):RE-78141

*50 pcs of paper cups and 50 pcs of plastic cups are included.

Package B Use It by placing VISCO™ on the base of Package B.

Low viscosity (1 to 2,000 mP·s) samples can be measured

Available as a package that comes with Ultra Low Adapter (ULA) for measuring low viscosity samples and VISCO™ (main unit).

VISCO™ Package B Cat.No.6811

VISCO™ Main Unit (accessories included)
Ultra Low Adapter (ULA) : RE-77120

VISCO™-895 Package B Cat.No.6831

VISCO™-895 Main Unit (accessories included)
Ultra Low Adapter (ULA) : RE-77120

Package C

The package C includes contents of package A & B

VISCO™ Package C Cat.No.6812

VISCO™ Main Unit (accessories included)
Cup Adapter (with 100pcs cups):RE-78141
Ultra Low Adapter (ULA) : RE-77120

VISCO™-895 Package C Cat.No.6832

VISCO™-895 Main Unit (accessories included)
Cup Adapter (with 100pcs cups):RE-78141
Ultra Low Adapter (ULA) : RE-77120

Package D NEW

Temperature controller for VISCO™

VISCO™Package D Cat.No.6813

VISCO™ Main Unit (accessories included)
VISCO Temp Controller Main Unit (accessories included)

VISCO™-895 Package D Cat.No.6833

VISCO™-895 Main Unit (accessories included)
VISCO Temp Controller Main Unit (accessories included)

VISCO™ Package

VISCO™ Temp Controller

The temperature controller is a lightweight, compact and constant temperature device that does not require water circulation.



Specifications

NEW

Cat.No.	VISCO™ Temp Controller	6900
Constant temperature setting range	5.0 to 90.0°C No lower than 10°C below or higher than 50°C above the ambient temperature)	
Resolution	0.1°C	
Accuracy	±0.2°C (at20°C)	
Environmental conditions	Temperature 5 to 40°C Humidity 35 to 70%(No condensation)	
Materials	Cup:Aluminum, Cup cover:PP	
Power supply	AC100 to 240V 50/60Hz	
Dimensions and Weight	Thermo module unit 130(φ)×162(H)mm, 2.7Kg Control unit 130(φ)×82(H)mm, 1.2Kg	

LED Specifications

Green	Red	Thermo module unit		LCD
●	●	ON	[Temperature] Present = Target	Present temperature
Light up	Off	ON	[Temperature] Present = Target	Present temperature
≡●≡	●	ON	[Temperature] Present = Target	Present temperature
Flash	Off	OFF		Present temperature
●	●	OFF(Set up mode)		Target temperature
Light up	Light up	OFF(Error)		Error messages
●	●			
Off	Light up			

VISCO™ Package

6 Reasons Why VISCO™ Temp Controller is Chosen

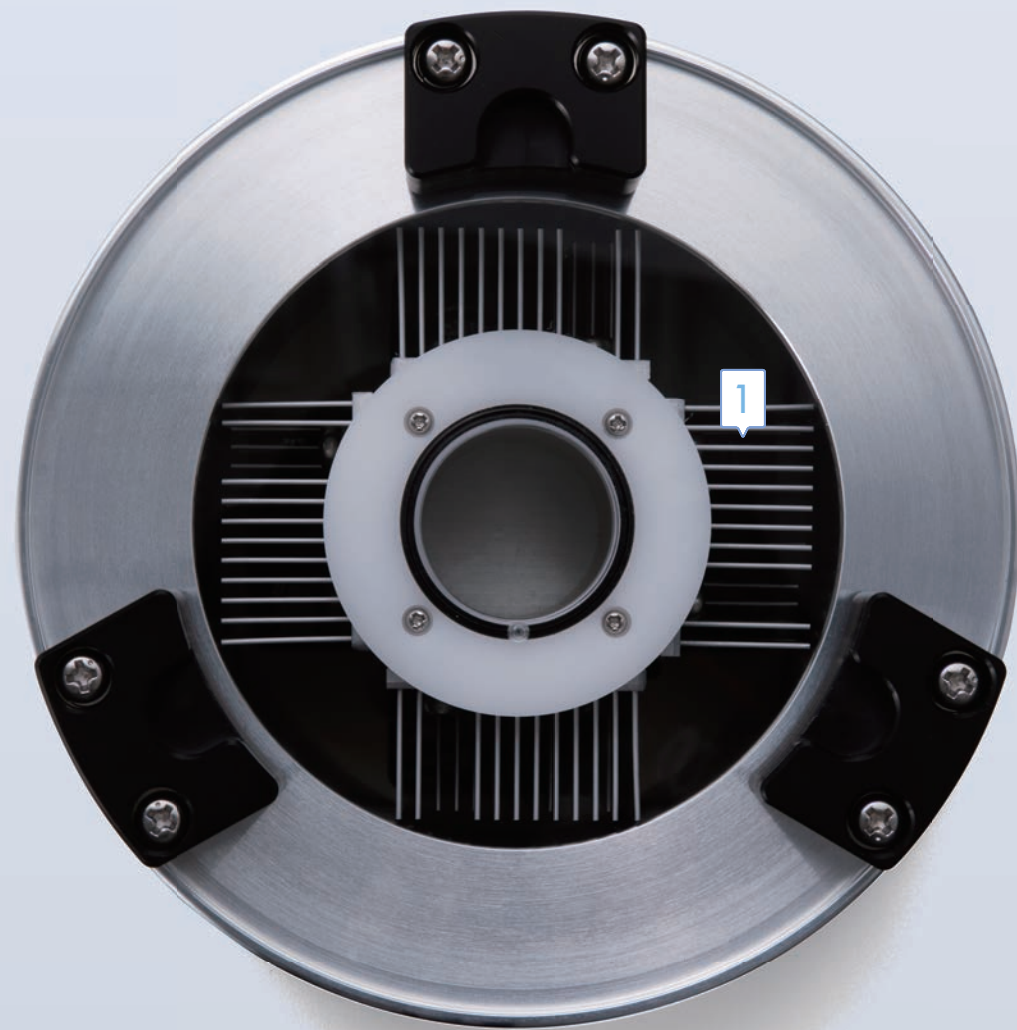

1 No water required

Because the viscosity is highly affected by temperature the test conditions to measure viscosity should be tightly controlled. Circulating baths are the most common choice for temperature control of test samples when performing viscosity measurements. It circulates water to control the temperature, but VISCO™ Temp Controller uses peltier module without needing to circulate water.

VISCO™ Temp Controller is more hygienic and does not require heavy loads preparation and disposal of water.

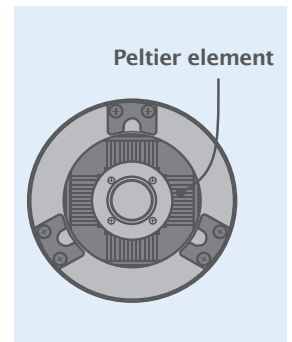

2 Reduced Time Spent

The time it takes for circulating water baths to adjust temperature can be long. In addition, for those that are not familiar can take more than 30 minutes to set it up, and easily spending more than 1 hour for prep time. The VISCO™ Temp Controller that requires no waiting for water to warm will need less time to control the sample temperature. Additionally, the aluminum sample holder allows heat to transfer quicker reducing even more time.

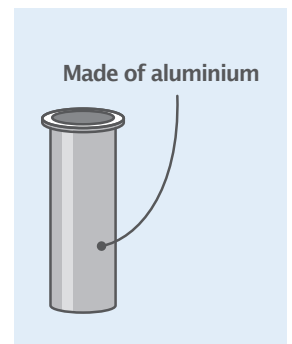

3 Lightweight and Compact

The total weight is about 4 kg and temperature control unit only is merely 2.7 kg. Less than half the weight of a typical constant temperature water bath. The size is just about the size of VISCO™ fitting perfect, without worrying about workspace.

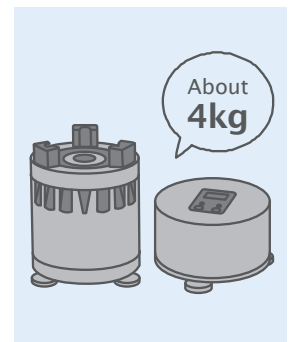

VISCO™ Package

6 Reasons Why VISCO™ Temp Controller is Chosen



4 Simple Operation

It is operated by two buttons. Despite the common notion that “apparatus and devices used for experiments are considered difficult without being a researcher or expert,” it is an easy to use product that anyone can use.

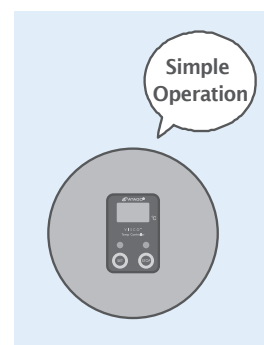

5 Uncompromised Design

A novel and stylish design that reverses the image of such conventional viscosity measurement, It can offer not only usability, but also an environment where users can comfortably measure viscosity.

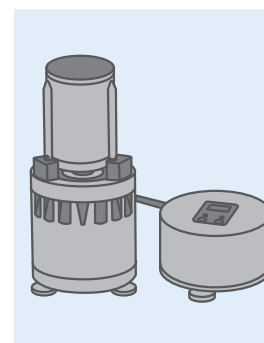

6 Environmentally friendly

Stress free from loud noise or vibration and environmentally friendly because it does not use refrigerants such as fluorocarbons.

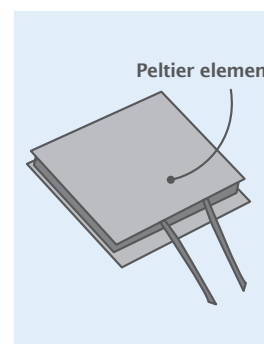



V I S C O TM B (L)

Liberation from All Previous Hassle
New Type of Digital Viscometer

PRODUCTS

VISCO™ B (L)

Liberation from All Previous Hassle New Type of Digital Viscometer



Specifications

NEW

Cat.No.	6840		
Measurement Scales	Viscosity, Temperature, Torque%		
Display Items	Viscosity, Temperature, Torque%, Speed, Spindle and beaker combination		
Measurement range	Viscosity	12 to 60,000,000mPa·S, 12 to 60,000,000cP	
	L1	12 to 600,000mPa·S, 12 to 600,000cP	
	L2	30 to 3,000,000mPa·S, 30 to 3,000,000cP	
	L3	48 to 12,000,000mPa·S, 48 to 12,000,000cP	
	L4	240 to 60,000,000mPa·S, 240 to 60,000,000cP	
	Torque	0.0 to 100.0% (recommended torque: 10.0 to 100.0%)	
Temperature	0.0 to 100.0°C, 32.0 to 212.0°F		
Resolution	Viscosity	lower than 100mPa·s	:0.01mPa·s
		100mPa·s or higher	lower than 10,000mPa·s :0.1mPa·s
		10,000mPa·s or higher	:1mPa·s
	Torque	Lower than 10%	:0.01%
		10% or higher	:0.1%
	Temperature	0.1°C/0.1°F	
Measurement Accuracy	Viscosity	±1% of Maximum Viscosity	
	Temperature	±0.2°C/±0.4°F	
Speed	0.01 to 250rpm		
	Number of Speeds: 28 levels		
Sample Temperature Range	10.0 to 40.0°C/50.0 to 104.0°F		
Environment Temperature	10 to 40°C		
Computer Communication	Output: USB - PC		
Power Supply	LR6 / AA alkaline batteries (x4)		
	AC adapter	input: AC100 to 240V. 50/60Hz, 0.3A output: 9V, 0.5A.	
Materials	Main unit	SUS316L	
	Stand	Aluminium	
	Rod	SUS303	
	Spindle	SUS316	
	Guard stirrup	SUS316L	
	Temperature sensor	SUS304/303	
Dimensions & Weight	Main unit	(W)178×(D)86×(H)194mm, 1.2kg	
	Stand and Rod	240×(H)398mm 2.8kg	
	Spindle L1	55g	
		L2	25g
		L3	13g
		L4	12g
	Guard stirrup S	43g	
	Guard stirrup L	52g	
	Temperature sensor	7g	

PRODUCTS

VISCO™ B (L)

< Measurement screen >

Measurement values are displayed large

- 1 Viscosity
- 2 User Scale
- 3 Power Supply Indicator/Remaining Battery Charge Indicator
- 4 Auto Stop
- 5 Spindle/Beaker
- 6 Temperature
- 7 Return
- 8 Speed
- 9 Torque %

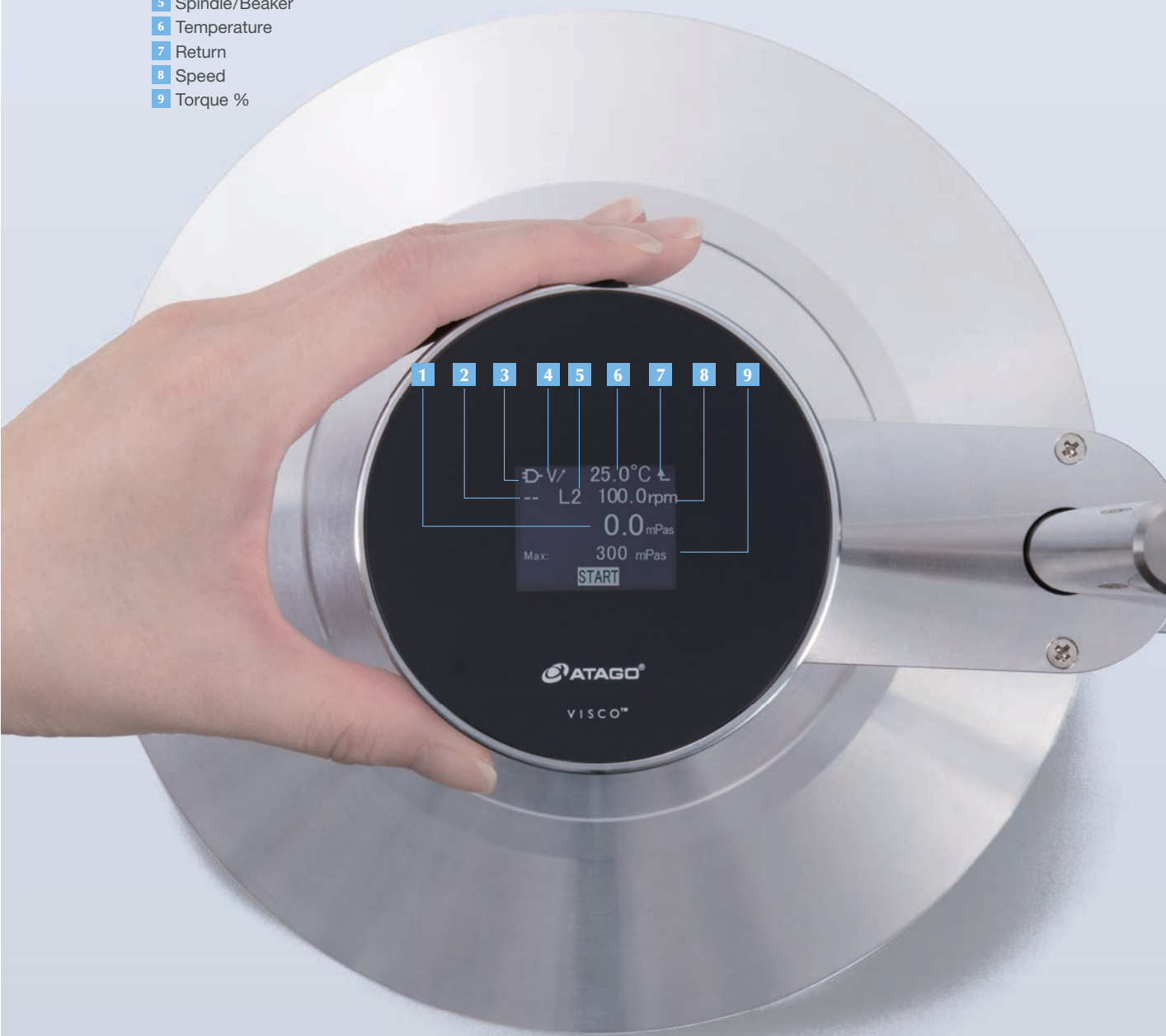

Content

1	Main unit	1
2	Stand	1
3	Stand screws	3
4	Spindles(L1,L2,L3 and L4)	one each
5	Temperature sensor	1
6	Temperature sensor holder	1
7	Rod	1
8	Guard stirrup(L)	1
9	Guard stirrup(S)	1
10	Spindle extension	1
11	USB Mini-B cable (1m)	1
12	1.5V AA alkaline batteries	4
13	AC adapter	1
14	Spindle stand	1
15	Protective cap	1
16	Stopper	1
17	Inspection certificate	1
18	Instruction manual	1



4

Four types of spindles, L1, L2, L3, and L4 are included.

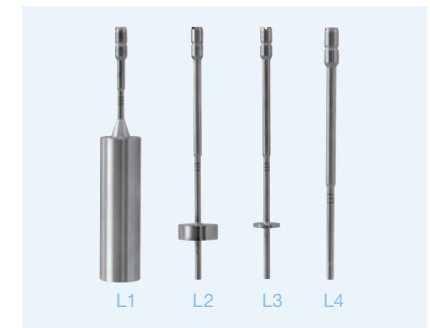

How to use

VISCO™ B (L)

Setup

Power ON

Level Check



Setup

Measurement

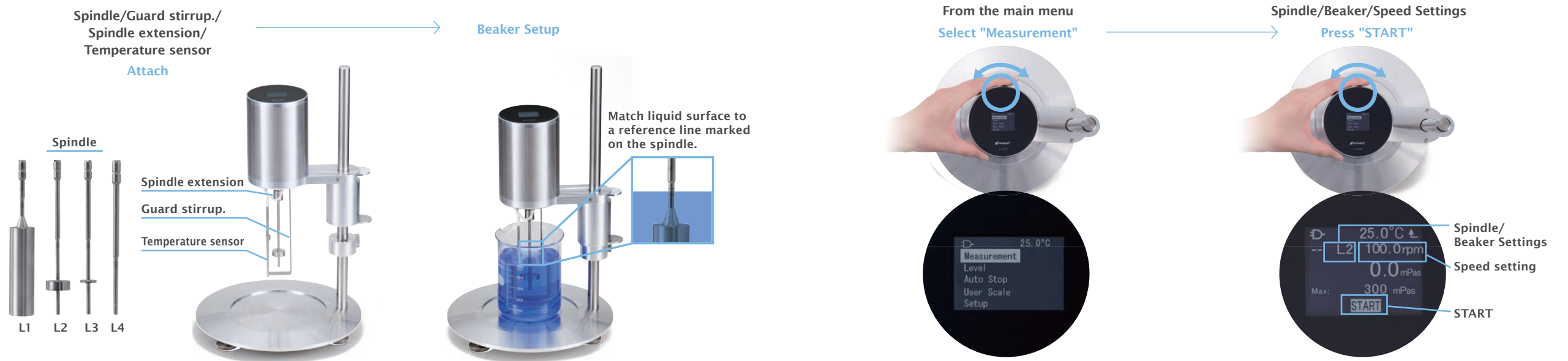

QUALITY

6 Reasons Why VISCO™ B(L) is Chosen

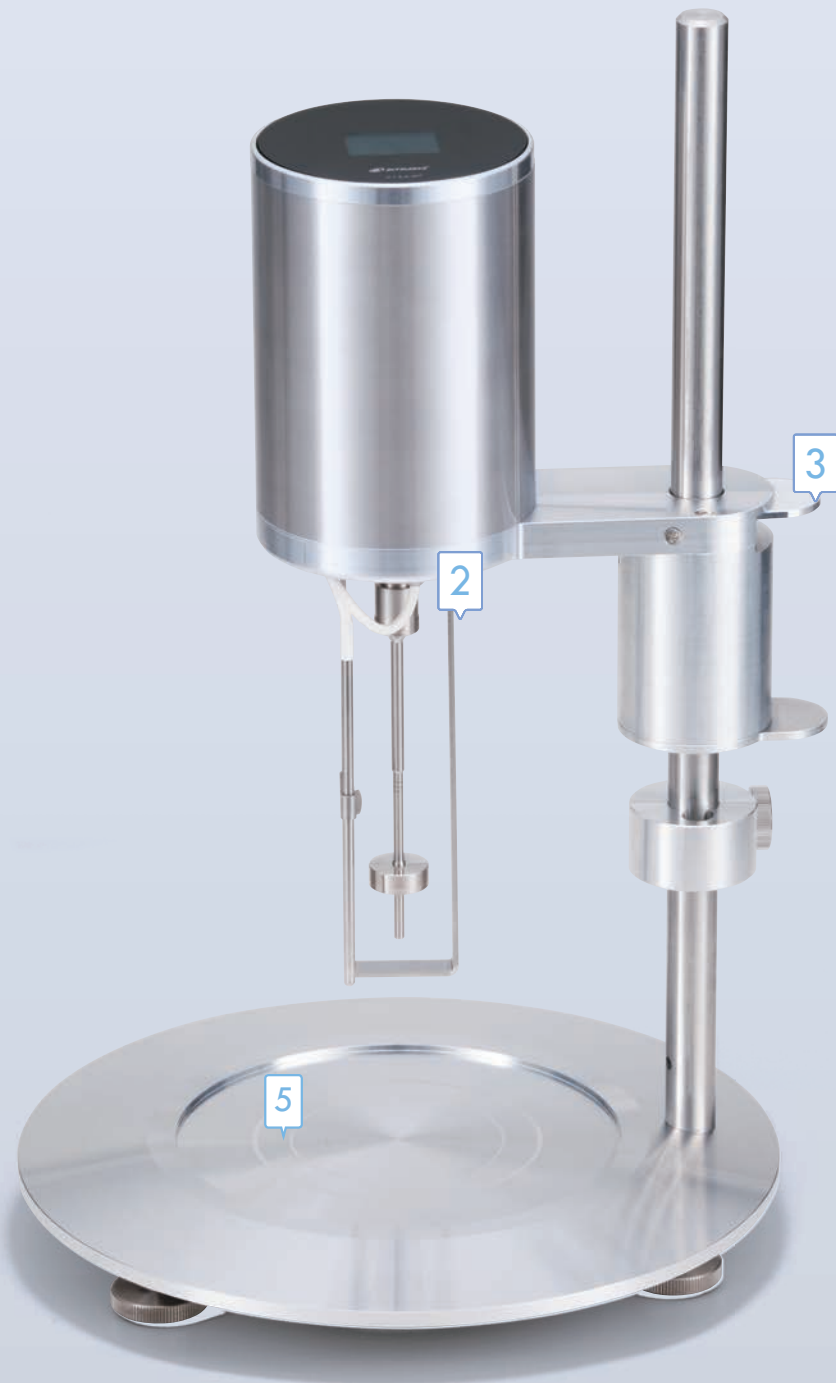

1 Easy Operation

ATAGO's VISCO™ B offers a simple set up and all operations can be done by one dial button for measurements which allows anyone to easily assemble and use.

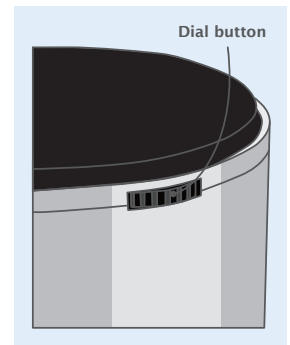

2 One Touch Spindle

Compared to the left-handed screw type that are commonly used with traditional Type-B viscometers, a spindle for VISCO™ B can be installed by simple one touch.

3 Smooth Height Adjustment

Many of the traditional Type-B viscometers that use left-hand screw requires to turn and twist screws to move it up and down causing tendonitis in some cases. With VISCO™ B, height can be adjusted simply by using a lever.

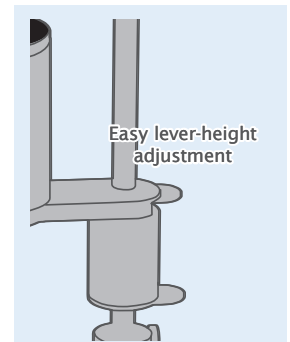

4 Digital Level Check

Traditional Type-B analog viscometers require visual check when leveling. VISCO™ B is digital and easily done.

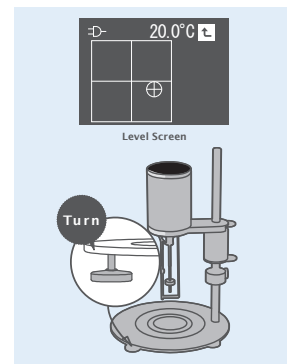

5 Don't let reference lines confuse you

Where to place a beaker is important. VISCO™ B has easy to follow guideline that takes away the ambiguity.

6 Stylish design

The VISCO™ B offers futuristic design that will brighten and bring fun to any measurement sites.

PRODUCTS

Water Jacket (for 500mL Beaker)



Specifications

NEW

Cat.No.	6845
Compatible Beaker Size	IS R 30053 500mL Beaker JIS R 3053 300mL Tall Beaker
Temperature Setting Range	5°C to 70°C
Required Fluid Volume (Excluding the hoses)	500 Beaker approximately 90mL 300 Tall Beaker approximately 260mL
Dimensions & Weight	(W)147×(D)150×(H)144mm, 1.9kg



OPTION VISCO™

Optional Accessories

Part No.	Part Name
< Container >	
RE-79100	15mL Beaker
RE-79101	100mL Beaker
RE-78141	Cup Adapter (with 100pcs cups) * 50pcs of paper cups and 50pcs of plastic cups are included.
RE-79102	Paper Cup (90mL, 100pcs)
RE-79103	Plastic Cup (90mL, 100pcs)



< Ultra Low Adapter (ULA) >

RE-77120	Ultra Low Adapter (ULA)- Sample Adapter for Low Viscosity Sample <ul style="list-style-type: none"> • Sample cylinder • Hook • Cylinder holder • Hook holder • Extension (threaded tip) • UL spindle • UL stand
RE-77107	UL spindle (with hook and hook holder)
RE-77121	Sample cylinder (with cap and o-ring)
RE-77117	UL spindle 3pcs (with hook and hook holder)

< Temperature sensor >

RE-75540	Temperature sensor
----------	--------------------

< Spindle >

RE-77104	A1 Spindle
RE-77105	A2 Spindle
RE-77106	A3 Spindle
RE-77114	A1 Spindle 5pcs
RE-77115	A2 Spindle 5pcs
RE-77116	A3 Spindle 5pcs
RE-77100	Set of spindles (A1,A2,A3)

The extra spindles will reduce cleaning time spent on washing after each use and lead to increased productivity.

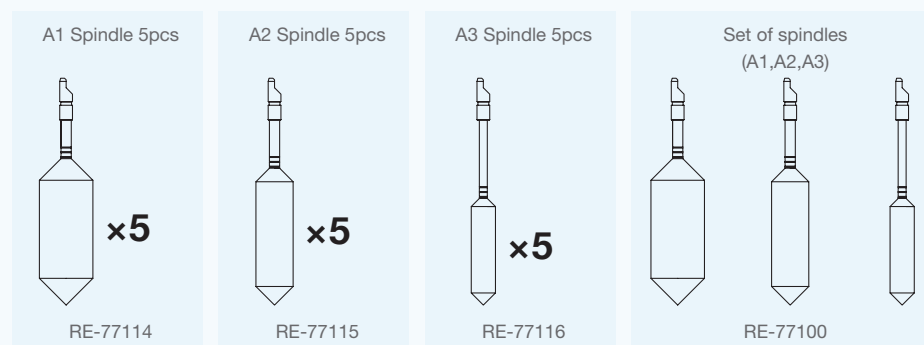

About Calibration

Calibration takes in consideration the relationship between the true value and the measurement value of the instrument. Calibration is an important task to ensure the reliability of the measurement results. It is recommended when there is drastic change in measurement environment or when questionable measurement results are shown. When considering periodical calibration, it is recommended to be determined based on the circumstance in which the measuring instrument is used and measurement history.

VISCO™ Standard Liquid

Choose from the following viscometer standard liquid 200, 500, or 1000 at the time of order. If you would like a viscosity liquid other than the above three points, please contact us separately.

Part No.	Part Name
<Standard liquid>	
RE-89030	Viscosity Standard Liquid 2 (100mL) (for ULA sample adapter)
RE-89031	Viscosity Standard Liquid 5 (100mL) (for ULA sample adapter)
RE-89036	Viscosity Standard Liquid 200 (100mL)
RE-89037	Viscosity Standard Liquid 500 (100mL)
RE-89038	Viscosity Standard Liquid 1000 (100mL)
RE-89039	Viscosity Standard Liquid 2000 (100mL)

*Shelflife 6 months.

Standard liquid with JCSS calibration certifications

If you would like a standard liquid with JCSS calibration, please click here.

Part No.	Part Name	Volume
<Standard liquid>		
RE-89010	STANDARD LIQUID JS2.5	Manufactured by Nippon Grease Co., Ltd (500mL)
RE-89011	STANDARD LIQUID JS5	Manufactured by Nippon Grease Co., Ltd (500mL)
RE-89012	STANDARD LIQUID JS10	Manufactured by Nippon Grease Co., Ltd (500mL)
RE-89013	STANDARD LIQUID JS20	Manufactured by Nippon Grease Co., Ltd (500mL)
RE-89014	STANDARD LIQUID JS50	Manufactured by Nippon Grease Co., Ltd (500mL)
RE-89015	STANDARD LIQUID JS100	Manufactured by Nippon Grease Co., Ltd (500mL)
RE-89016	STANDARD LIQUID JS200	Manufactured by Nippon Grease Co., Ltd (500mL)
RE-89017	STANDARD LIQUID JS500	Manufactured by Nippon Grease Co., Ltd (500mL)
RE-89018	STANDARD LIQUID JS1000	Manufactured by Nippon Grease Co., Ltd (500mL)
RE-89019	STANDARD LIQUID JS2000	Manufactured by Nippon Grease Co., Ltd (500mL)
RE-89020	STANDARD LIQUID JS14000	Manufactured by Nippon Grease Co., Ltd (500mL)
RE-89021	STANDARD LIQUID JS52000	Manufactured by Nippon Grease Co., Ltd (500mL)
RE-89022	STANDARD LIQUID JS160000	Manufactured by Nippon Grease Co., Ltd (500mL)

OPTION VISCO™ B(L)

Optional Accessories

Part No.	Part name
< Spindle >	
RE-77108	Spindle L1
RE-77109	Spindle L2
RE-77110	Spindle L3
RE-77111	Spindle L4

Circulating Constant Temperature Bath



60-C5

Cat.No.1923

A circulating water bath for precise temperature control of refractometers without Peltier. The temperature range can be set from 10 to 60°C and its compact, easy to use design makes it optimal for connecting to a refractometer.

Temperature setting range	10.0 to 60.0°C (Temperature setting range is limited by ambient temperature, as well as the model of external connecting devices.)
Minimum temperature indication	0.1°C
Temperature accuracy	±0.2°C Conditions: At ambient temperature of 20°C, on stand-by, and using shortest tube (0.2m) with insulation.
Temperature control method	PID control using a thermo module
Pump capacity	Approx. 6 liters/min (When connected with a 0.2m tube with an internal diameter of 8mm.)
Power consumption	250VA
Environmental conditions	Temperature: 5 to 40°C, Humidity: 35 to 70% (No condensation formation.)
Safety device (features)	Water level monitor to prevent empty pump operation and overheating prevention feature.
Power supply	AC 100 to 240V , 50/60Hz
Dimensions and weight	204 (W) x 336 (D) x 289 (H) mm, approx. 9kg

About Calibration

Calibration takes in consideration the relationship between the true value and the measurement value of the instrument. Calibration is an important task to ensure the reliability of the measurement results. It is recommended when there is drastic change in measurement environment or when questionable measurement results are shown. When considering periodical calibration, it is recommended to be determined based on the circumstance in which the measuring instrument is used and measurement history.

VISCO™ B(L)Standard Liquid

Part No.	Part name
<Standard liquid>	
RE-89053	Viscosity Standard Liquid 20 (500mL)
RE-89054	Viscosity Standard Liquid 50 (500mL)
RE-89055	Viscosity Standard Liquid 100 (500mL)
RE-89056	Viscosity Standard Liquid 200 (500mL)
RE-89057	Viscosity Standard Liquid 500 (500mL)
RE-89058	Viscosity Standard Liquid 1000 (500mL)
RE-89059	Viscosity Standard Liquid 2000 (500mL)

Standard liquid with JCSS calibration certifications

If you would like a standard liquid with JCSS calibration, please click [here](#).

Part No.	Part name	
<Standard liquid>		
RE-89013	Standard liquid JS20	Manufactured by Nippon Grease Co., Ltd (500mL)
RE-89014	Standard liquid JS50	Manufactured by Nippon Grease Co., Ltd (500mL)
RE-89015	Standard liquid JS100	Manufactured by Nippon Grease Co., Ltd (500mL)
RE-89016	Standard liquid JS200	Manufactured by Nippon Grease Co., Ltd (500mL)
RE-89017	Standard liquid JS500	Manufactured by Nippon Grease Co., Ltd (500mL)
RE-89018	Standard liquid JS1000	Manufactured by Nippon Grease Co., Ltd (500mL)
RE-89019	Standard liquid JS2000	Manufactured by Nippon Grease Co., Ltd (500mL)

What is the difference between VISCO™ and VISCO™-895?

VISCO™ is the SUS model, and the VISCO™-895 is an aluminum model. The main unit weighs 1.2kg (VISCO™) and 895g (VISCO™-895).

Please choose accordingly.

Is there anything else I need besides the main unit?

The VISCO™ and VISCO™-895 comes with the main unit as well as the spindles, thermometer and beakers required for measurements. You can start measuring as soon as you take it out of the box.

For low viscosity samples, purchase Package B with a low viscosity adapter.

Select a single speed.

Three types of spindles are included. Please contact our sales department for the selection guidance. There are also guidelines for each type of beaker size, speed, and spindle in the instruction manual.

Note that when the torque is less than 10%, the load is not enough. Be sure to choose to between 10 and 100%.

When speed and/or the size of the beaker is changed, it shows different viscosity measurements. Is it measuring correctly?

When the speed and/or the size of the beaker is changed, the viscosity also changes. This is because the viscosity is influenced by measurement conditions.

When measuring the same sample, use the same measurement conditions.

The spindle has a reference and fill lines, but which one should I match?

Please measure by putting the sample to the reference line.

Is it possible to output data?

Data can be output using a USB-Mini-B cable.

Why is water not measured as 1mPas?

The viscosity of the water is defined as 1mPa·s, but this is a theoretical value, not a measured value. In fact, because various conditions may affect measurements, a value close to 1 is displayed.

Can it be calibrated?

It can be calibrated using a viscometer standard solution. For the value of the standard liquid, please check the measured value in the accompanying instruction manual.

Please refer to P.B47.

Does it correlate to B type viscometer?

There are samples that can be correlated samples and others not. Free trial unit can allow you to check for correlations.

If there is a correlation, you can set the same value to display by using the user scale function.

Can temperature be adjusted?

Temp controller can be used. Be careful not to let water in the sample.

How much sample do I need?

It can be measured at 15mL when using the beaker S (included) and 100mL when using the beaker L.

What kind of maintenance is required?

Use the viscosity standard liquid optionally sold regularly.

How can hot samples be measured?

Set the wait time to create a temperature compensation table for the measurement sample.

For more information, please ATAGO.